

# ***Nikon***

The Nikon Guide to Digital Photography  
with the

# **COOLPIX 995**

DIGITAL CAMERA

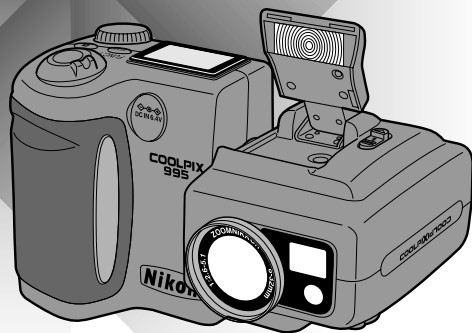

CE E

# Before Using the Camera

This chapter provides information that you should read before using this camera.

## For Your Safety

This section contains important safety information. Read this section in its entirety before using your COOLPIX995 or the software provided with your camera.

---

### Warnings and Cautions

The symbols listed below are used in this guide and in other documentation to indicate warnings and cautions that should be read before use.

#### **Warning**

This symbol is used to mark warnings that should be read before use to prevent possible injury.

#### **Caution**

This symbol indicates where caution should be exercised to avoid damaging your Nikon product.

---

### Warnings

To prevent injury, observe the following warnings when using your Nikon product.

#### **Do not look at the sun through the Viewfinder**

Viewing the sun or other strong light source through the Viewfinder could cause permanent visual impairment.

#### **Turn off immediately in the event of malfunction**

Should you notice smoke or an unusual smell coming from the equipment or from the AC adapter (available separately), unplug the AC adapter and remove the battery immediately, taking care to avoid burns. Continued operation could result in injury. After removing the battery, take the equipment to a Nikon-authorized service center for inspection.

#### **Do not use in the presence of flammable gas**

Do not use electronic equipment in the presence of flammable gas, as this could result in explosion or fire.

#### **Do not place camera strap around neck**

Placing the camera strap around your neck could result in strangulation. Special care should be taken to avoid placing the strap around the neck of an infant or child.

#### **Do not disassemble**

Touching the product's internal parts could result in injury. In the event of a malfunction, the product should be repaired only by a qualified technician. Should the product break open as the result of a fall or other accident, remove the battery and/or AC adapter and then take the product to a Nikon-authorized service center for inspection.

## **Observe proper precautions when handling the battery**

The battery may leak or explode if improperly handled. Observe the following precautions when handling the battery for use in this product:

- Make sure the product is off before replacing the battery. If you are using the AC adapter, Make sure it is unplugged.
- Use only the supplied rechargeable Nikon EN-EL1 lithium-ion battery or a 6V 2CR5 (DL245) lithium battery (available separately).
- When inserting the battery, do not attempt to insert it upside down or backwards.
- Do not short-circuit or disassemble the battery.
- Do not expose the battery to flame or to excessive heat.
- Do not immerse in or expose to water.
- Do not transport or store with metal objects such as necklaces or hairpins.
- The battery is prone to leakage when fully discharged. To avoid damage to the product, be sure to remove the battery when no charge remains.
- When the battery is not in use, attach the terminal cover and store in a cool place.
- Discontinue use immediately should you notice any changes in the battery, such as discoloration or deformation.

## **Use appropriate cables**

When connecting cables to the input and output jacks, use only the cables provided or sold by Nikon for the purpose, to maintain compliance with product regulations.

## **Keep out of reach of children**

Particular care should be taken to prevent infants from putting the battery or other small parts into their mouths.

## **Do not walk while looking through the Viewfinder**

Walking while looking through the camera's Viewfinder or color LCD monitor could result in a fall or other injury.

## **Removing memory cards**

Memory cards may become hot during use. Observe due caution when removing memory cards from the camera.

## **CD-ROMs**

The CD-ROMs on which the software and manuals are distributed should not be played back on audio CD equipment. Playing CD-ROMs on an audio CD player could cause hearing loss or damage the equipment.

## **Observe caution when operating the flash**

Using the flash close to your subject's eyes could cause temporary visual impairment.

## **When using the Viewfinder**

When operating the diopter adjustment dial with your eye to the Viewfinder, care should be taken not to put your finger in your eye accidentally.

---

## **Cautions**

Observe the following precautions to ensure that you continue to get the most from your Nikon product.

### **Keep dry**

This product is not waterproof, and may malfunction if immersed in water or exposed to high levels of humidity.

### **Keep free of salt, sand, and dust**

After using your camera at the beach or seaside, wipe off any sand or salt with a lightly dampened cloth and then dry your camera thoroughly.

### **Do not touch the lens with your fingers**

The proper procedure for cleaning the lens is described on page 165 of this document.

### **Handle the lens and all moving parts with care**

Do not apply force to the lens or to the battery, card, or connector covers. These parts are especially susceptible to damage.

### **Do not unplug the product or remove the battery while the product is on**

Do not unplug the product or remove the battery while the camera is on, or while images are being recorded or deleted from memory. Forcibly cutting power to the product in these circumstances could result in loss of data or in damage to the internal circuitry or memory. To prevent an accidental interruption of power, avoid carrying the product from one location to another while the AC adapter is connected.

## ✓ Do not drop

The product may malfunction if subjected to strong shocks or vibration. Attach the strap (p. 40) and lens-cap cord and keep the strap around your wrist when carrying the camera.

## ✓ Keep away from strong magnetic fields

Do not use or store this device in the vicinity of equipment that produces strong electromagnetic radiation or magnetic fields. The magnetic fields produced by equipment such as radio transmitters or household television sets could interfere with the color monitor, damage data stored on the flash-memory card, or affect the product's internal circuitry.

## ✓ Avoid sudden changes in temperature

Sudden changes in temperature, such as occur when entering or leaving a heated building on a cold day, can cause condensation inside the device. To prevent condensation, place the device in its carrying case or a plastic bag before exposing it to sudden changes in temperature.

## ✓ Batteries

When you turn the device on, check the battery-level displayed in the control panel to determine whether the battery needs to be replaced. The battery needs to be replaced when the battery-level indicator is flashing.

The battery-level indicator may briefly show  (battery fully charged) after an exhausted battery is reinserted in the camera.

On cold days, the capacity of the battery tends to decrease. When taking pictures outside in cold weather, keep a warm spare battery on hand.

Should the battery terminals become dirty, wipe them with a clean, dry cloth before use.

## ✓ Memory cards

Observe the following precautions when handling CompactFlash™ memory cards:

- Turn the power off before inserting or removing memory cards. Inserting or removing cards with the power on could render them unusable.
- Insert memory cards as shown on page 36. Inserting cards upside down or backwards could damage the camera or the card.

## Notice for customers in Canada

### CAUTION

This Class B digital apparatus meets all requirements of the Canadian Interference Causing Equipment Regulations.

### ATTENTION

Cet appareil numérique de la classe B respecte toutes les exigences du Règlement sur le matériel brouilleur du Canada.

## Notice for customers in the U.S.A.

### Federal Communications Commission (FCC) Radio Frequency Interference Statement

This equipment has been tested and found to comply with the limits for a Class B digital device, pursuant to Part 15 of the FCC rules.

These limits are designed to provide reasonable protection against harmful interference in a residential installation. This equipment generates, uses, and can radiate radio frequency energy and, if not installed and used in accordance with the instructions, may cause harmful interference to radio communications. However, there is no guarantee that interference will not occur in a particular installation. If this equipment does cause harmful interference to radio or television reception, which can be determined by turning the equipment off and on, the user is encouraged to try to correct the interference by one or more of the following measures:

- Reorient or relocate the receiving antenna.
- Increase the separation between the equipment and receiver.
- Connect the equipment into an outlet on a circuit different from that to which the receiver is connected.
- Consult the dealer or an experienced radio/television technician for help.

### CAUTIONS

#### Modifications

The FCC requires the user to be notified that any changes or modifications made to this device that are not expressly approved by Nikon Corporation may void the user's authority to operate the equipment.

#### Interface Cables

Use the interface cables sold or provided by Nikon for your equipment. Using other interface cables may exceed the limits of Class B Part 15 of the FCC rules.

Nikon Inc.

1300 Walt Whitman Road, Melville, New York

11747-3064, U.S.A.

Tel.: 631-547-4200

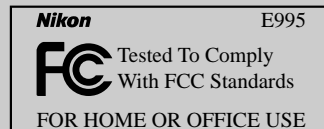

## Notice Concerning Prohibition of Copying or Reproduction

Note that simply being in possession of material that has been digitally copied or reproduced by means of a scanner, digital camera or other device may be punishable by law.

### Items prohibited by law from being copied or reproduced

Do not copy or reproduce paper money, coins or securities, government bonds, or local government bonds, even if such copies or reproductions are stamped "Sample."

The copying or reproduction of paper money, coins, or securities which are circulated in a foreign country is prohibited.

Unless the prior permission of the government has been obtained, the copying or reproduction of unused postage stamps or post cards issued by the government is prohibited.

The copying or reproduction of stamps issued by the government and of certified documents stipulated by law is prohibited.

### Cautions on certain copies and reproductions

The government has issued cautions on copies or reproductions of securities issued by private companies (shares, bills, checks, gift certificates, etc.), commuter passes, or coupon tickets, except when a minimum of necessary copies are to be provided for business use by a company. Also, do not copy or reproduce passports issued by the government, licenses issued by public agencies and private groups, ID cards, or tickets, such as passes and meal coupons.

### Comply with copyright notices

The copying or reproduction of copyrighted creative works such as books, music, paintings, woodcut prints, maps, drawings, movies and photographs is prohibited except when it is done for personal use at home or for similar restricted and non-commercial use.

## Notices

### Concerning the Manuals Provided with This Product

- Reproduction, in whole or in part, of any of the manuals provided with your Nikon product requires prior permission from Nikon.
- The information contained in these manuals is subject to change without notice.
- While Nikon has made every effort to produce perfect manuals, we appreciate any opportunity for improvement. Should you find any mistakes, we would be grateful if you were to kindly let us know. The address of Nikon's representative in your area is provided separately.

### Disclaimer of Liability

- Nikon does not accept liability for damages resulting from the use of this product.

### A Note on Memory Cards

Your digital camera uses CompactFlash flash-memory cards to store photographs.

While any card conforming to CompactFlash specifications can be used, performance may vary depending on the make of card. Nikon CompactFlash memory cards are recommended.

### Trademark Information

Apple, the Apple logo, Macintosh, and QuickTime are registered trademarks of Apple Computer, Inc. Finder, Macintosh PC Exchange, Power Macintosh and PowerBook are trademarks of Apple Computer, Inc. IBM and IBM PC/AT are registered trademarks of International Business Machines Corporation. PowerPC is a trademark of International Business Machines Corporation, used under license. Microsoft is a registered trademark, and Windows, MS-Windows and Windows NT are trademarks, of Microsoft Corporation. Internet Explorer is a product of Microsoft Corporation. Pentium and i486 are trade-marks of Intel Corporation. Internet is a trademark of Digital Equipment Corporation. Netscape and Netscape Navigator are registered trademarks of Netscape Communications Corporation. CompactFlash is a trademark of SanDisk Corporation. Adobe and Acrobat are registered trademarks of Adobe Systems Inc. Zip is a registered trademark of Iomega Corporation in the U.S. and other countries. All other trade names mentioned in this manual or the other documentation provided with your Nikon product are trademarks or registered trademarks of their respective holders.

# Introduction

Thank you for purchasing the Nikon COOLPIX995 digital camera—a camera that is sure to make photography a bigger part of your life. Get to know your COOLPIX995 digital camera, and be sure to read this manual thoroughly before using it. We recommend that you keep this manual handy.

## Fast Track Guide

In addition to taking first time users step-by-step through the process of setting up and using the camera, the printed Fast Track Guide gives a quick overview of camera settings.

## Take trial shots

Take trial shots before shooting at important occasions like weddings or graduations.

## Have Nikon check your camera regularly

Nikon recommends that you have your camera serviced by an authorized dealer or service center at least once every two years.

## Using your camera correctly

The Nikon COOLPIX995's performance has been optimized for use with Nikon brand accessories. Accessories made by other manufacturers may not meet Nikon's criteria for specifications, and nonconforming accessories could damage the COOLPIX995's components. Nikon cannot guarantee the COOLPIX995's performance when it is used with other than Nikon brand accessories.

### Life-Long Learning

As part of Nikon's "Life-Long Learning" commitment to ongoing product support and education, continually-updated information is available on-line at the following sites:

- For users in the U.S.A.: <http://www.nikonusa.com/>
- For users in Europe: <http://www.nikon-euro.com/>
- For users in Asia, Oceania, the Middle East, and Africa: <http://www.nikon-asia.com/>

Visit these sites to keep up-to-date with the latest product information and general advice on digital imaging and photography.

For more information, please contact your nearest Nikon representative.



<http://www.nikon-image.com/eng/>

# About This Manual

This manual is organized in a progressive fashion from basic operations to more advanced operations so you get to know the camera better and better as you operate it following the instructions.

<b>Before Using the Camera</b>	This section includes information necessary before using this camera, such as precautions for safe use, nomenclature, a quick guide, a menu guide, etc.
<b>Preparation</b>	This section introduces necessary preparations such as installing the battery, inserting the CF memory card and making various camera settings before using the camera.
<b>Useful Advice on COOLPIX Camera Techniques</b>	This section introduces useful advice on COOLPIX camera techniques such as how to hold the camera and how to press the Shutter release button.
<b>Simple Shooting and Playback</b>	This section explains some aspects of simple "Point and Shoot" photography and simple playback operation.
<b>Detailed Operations</b>	This section includes detailed explanations of shooting, playback and deletion of images.
<b>Advanced Operations</b>	This section provides complete descriptions of advanced camera operations.
<b>Using the Camera Menus</b>	This section gives detailed explanations of menu items in the Shooting and Playback modes.
<b>Connections</b>	This section describes connection to external devices such as TV sets or personal computers.
<b>Miscellaneous</b>	This section covers optional accessories, troubleshooting and specifications.

# Contents

<b>Before Using the Camera</b> .....	<b>2-27</b>
For Your Safety .....	3-9
Introduction .....	10
About This Manual .....	11
Nomenclature .....	14-17
Quick Guide .....	18-21
Menu Guide:  Shooting Mode .....	22-23
Menu Guide:  Shooting Mode .....	24-25
Menu Guide:  Playback Mode .....	26-27
<b>Preparation</b> .....	<b>29-40</b>
Installing Battery .....	30-31
Selecting a Language .....	32-33
Setting Date/Time .....	34-35
Inserting CF Memory Card .....	36-37
Formatting CF Memory Cards .....	38-39
Strap and Lens Cap .....	40
<b>Useful Advice on COOLPIX Camera Techniques</b> .....	<b>41-44</b>
Holding the Camera .....	42
Holding the Camera/Pressing the Shutter Release Button .....	43
Mode Dial and Multi Selector .....	44
<b>Simple Shooting and Playback</b> .....	<b>45-56</b>
Basic Operation (Auto Mode) .....	46-52
Self-Timer Operation .....	53
Simple Playback Operations .....	54-55
Other Functions .....	56
<b>Detailed Operations</b> .....	<b>57-78</b>
Setting Image Quality and Size .....	58-59
How Much Space is Left on My CF Memory Card— Confirming the Number of Exposures Remaining .....	60
Selecting the Focus Mode .....	61-62
Digital Zoom .....	63
Setting the Exposure mode .....	64-68
Setting the Flash Mode .....	69-70
Setting the Exposure Compensation Value .....	71
Adjusting Sensitivity .....	72-73
Playback .....	74-76
Deleting Photographs .....	77-78

<b>Advanced Operations</b> .....	<b>79-90</b>
Autofocus Lock/Auto Exposure Lock .....	80
Manual Focus .....	81
Situations Where Autofocus May not Work as Expected .....	82
Recording Movie/Movie Playback .....	83-84
Quick Delete/Holding the Image in the Display .....	85
Quick Review Mode/Full-Screen Review Mode .....	86-87
Viewing Additional Picture Information .....	88-89
Sync Terminal .....	90
<b>Using the Camera Menus</b> .....	<b>91-152</b>
Setting Shooting Menus .....	92-119
Setting Shooting SET-UP Menus .....	120-135
Playback Menus .....	136-147
Playback SET-UP Menus .....	148-152
<b>Connections</b> .....	<b>153-160</b>
Connecting to an AC Adapter (optional) .....	154
Connecting to a television or VCR .....	155
Connecting to a computer .....	156-160
<b>Miscellaneous</b> .....	<b>161-179</b>
Optional Accessories .....	162-164
Operating Conditions .....	164
Caring for Your Camera .....	165
Troubleshooting .....	166-167
Error Messages .....	168-171
Specifications .....	172-175
Index .....	176-179

# Nomenclature

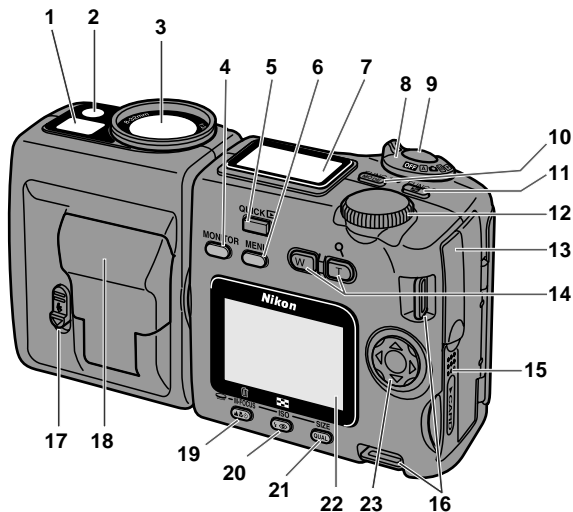

Inside memory card slot cover

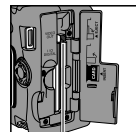

Memory card eject lever

Inside video output connector/ USB connector cover

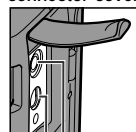

Video output connector  
USB connector

Speedlight up

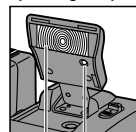

Flash sync sensor  
Photocell

- 1 Viewfinder p. 16
- 2 Red-eye reduction/Self-timer lamp p. 70/53
- 3 Lens
- 4 MONITOR button p. 46
- 5 QUICK review button p. 51
- 6 MENU button p. 92
- 7 Control panel p. 16
- 8 Mode dial p. 44
- 9 Shutter release button p. 43
- 10 MODE/FUNC (function) 1 button p. 64/130
- 11 Exposure Compensation/FUNC (function) 2 button p. 71/131
- 12 Command dial
- 13 Video output connector/USB connector cover p. 155/157
- 14 Zoom buttons p. 47
- 15 Memory card slot cover p. 36
- 16 Camera strap eyelets p. 40
- 17 Speedlight lock-release lever p. 50
- 18 Built-in Speedlight p. 50
- 19 Focus mode/Manual focus/Delete button p. 61/81/77
- 20 Flash mode/Sensitivity/Thumbnail button p. 69/72/55
- 21 Image quality/Image size button p. 58/59
- 22 Monitor p. 17
- 23 Focus area/Multi selector p. 111/44

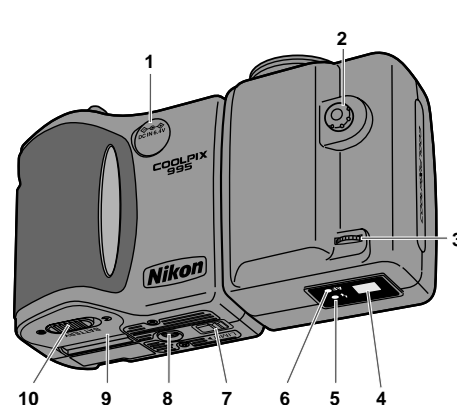

Opening Sync terminal cover

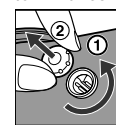

- 1 DC-in connector cover p. 154
- 2 Sync terminal p. 90
- 3 Diopter adjustment dial p. 43
- 4 Viewfinder eyepiece p. 16
- 5 Red LED p. 16
- 6 Green LED p. 16
- 7 Swivel lock lever p. 106
- 8 Tripod socket
- 9 Battery chamber cover p. 30
- 10 Battery chamber cover latch p. 30

## ■ The following buttons have different functions in different modes:

Refer to the figure on p. 14 for the location of each button.

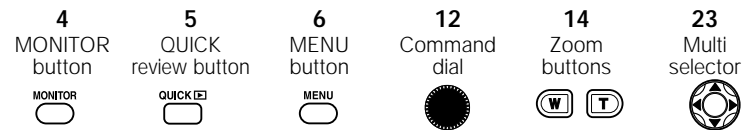

\* Functions of buttons 19, 20 and 21 on page 14 differ in Shooting mode and Playback mode; these buttons are indicated as follows in this manual.

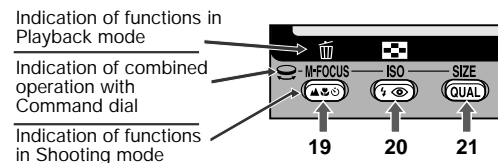

Indication in Shooting mode		19 Focus mode button		20 Flash mode button		21 Image quality button
Indication in Playback mode		Delete button		Thumbnail button		QUAL button



## Control Panel

(All indications are displayed in the illustration for easy reference.)

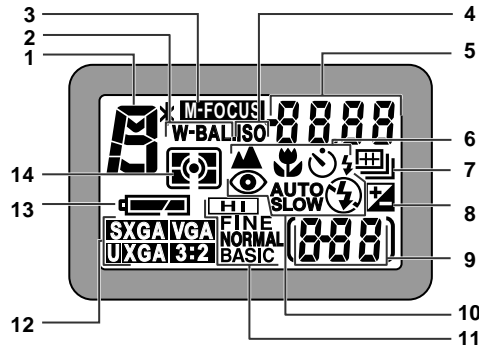

- |   |  |
|---|--|
| 1 Exposure mode p. 64                                 | 8 Exposure Compensation p. 71  |
| 2 White balance p. 95                                 | 9 Number of exposures remaining/<br>Exposure condition/Image transfer<br>indication p. 60/68/157 |
| 3 Manual focus p. 81                                  | 10 Flash mode p. 69  |
| 4 ISO/Sensitivity p. 72                               | 11 Image quality mode p. 58  |
| 5 Aperture/Shutter speed/Various<br>numerical values* | 12 Image size p. 59  |
| 6 Focus mode/Self-timer p. 61/53                      | 13 Battery status indicator p. 31  |
| 7 Continuous shooting p. 99                           | 14 Metering mode p. 97   |

\* Displays numerical values such as shutter speed in Shutter-Priority Auto/Manual Exposure mode, aperture in Aperture-Priority Auto/Manual Exposure mode, Exposure Compensation value when Exposure Compensation is enabled, focus distance when using Manual focus or sensitivity depending upon the functions used.

## Viewfinder/LED

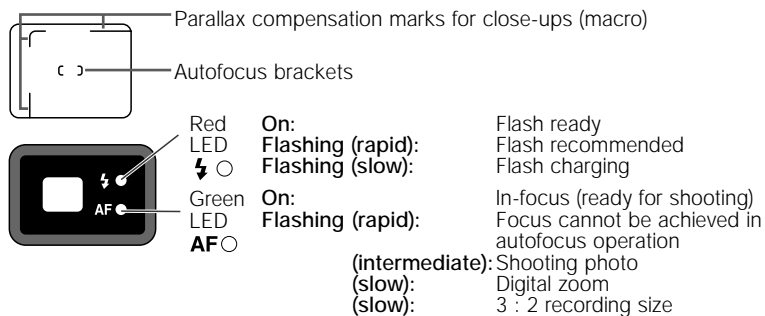

## Monitor (in Shooting mode)

- 
- |   |    |    |
|---|----|----|
| 1 User Setup Number*1 p. 108                                    | 8  | 14 |
| 2 Self-timer/Count down p. 53                                   | 9  | 15 |
| 3 Zoom/Ultra HS p. 47/99  | 10 | 16 |
| 4 Digital zoom magnification factor p. 63                       | 11 | 17 |
| 5 Clock*2 p. 33   | 12 | 18 |
| 6 Focus distance when in Manual focus p. 81                     | 13 | 19 |
| 7 Flash mode p. 69  |    | 20 |
| 8 Current Folder name*3 p. 122                                  |    | 21 |
| 9 Lens converter selection p. 106                               |    | 22 |
| 10 Best Shot Selector/Noise Reduction p. 102/117                |    | 23 |
| 11 Exposure lock (Auto exposure lock/White balance lock) p. 109 |    | 24 |
| 12 Exposure bracketing/White balance bracketing p. 115/116      |    | 25 |
| 13 Continuous shooting p. 99                                    |    | 26 |
| 14 Battery power*4 p. 31  |    | 27 |
| 15 Spot exposure metering area/AF area p. 98/111                |    | 28 |
| 16 Image sharpening p. 114                                      |    |    |
| 17 White balance p. 95  |    |    |
| 18 Sensitivity adjustment p. 72                                 |    |    |
| 19 Image adjustment/Black-and-white p. 104/105                  |    |    |
| 20 Image size p. 59   |    |    |
| 21 Image quality p. 58  |    |    |
| 22 Metering mode p. 97  |    |    |
| 23 Exposure mode p. 64  |    |    |
| 24 Shutter speed p. 66  |    |    |
| 25 Exposure meter p. 67   |    |    |
| 26 Aperture p. 66   |    |    |
| 27 Exposure Compensation/Exposure Compensation values p. 71     |    |    |
| 28 Number of exposures remaining/<br>Movie duration p. 60/100   |    |    |

## Monitor (in Playback mode)

- 
- |  |    |
|--|----|
| 1 Image date p. 34                       | 5  |
| 2 Image time p. 34                       | 6  |
| 3 Image size p. 59                       | 7  |
| 4 Image quality p. 58                    | 8  |
| 5 Folder name p. 140                     | 9  |
| 6 File number p. 74                      | 10 |
| 7 Battery power*4 p. 31                  | 11 |
| 8 Auto transfer p. 146                   |    |
| 9 Print-order selection p. 144           |    |
| 10 Protect on p. 142                     |    |
| 11 Frame number of displayed image p. 74 |    |

\*1 Not displayed when User Setting Number 1 is set.

\*2 Flashes when date/time setting is not set.

\*3 Not displayed when folder name is set to NIKON.

\*4 Not displayed when battery power is sufficient.

# Quick Guide

This section will rapidly guide you through the first steps, from setting up the camera to taking your first picture. For fully detailed descriptions of each operation, please see the page referred as "(p. 00)".

1 Set the Mode dial to **OFF** and insert the battery (p. 30).

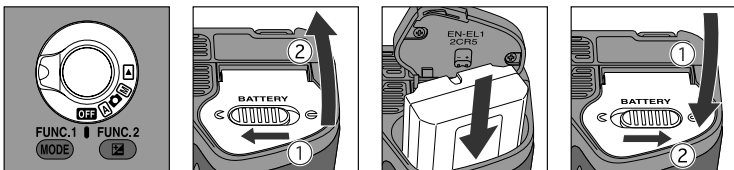

2 Insert the CF memory card (p. 36).

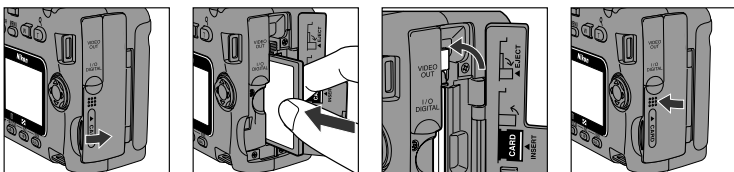

• Gently insert the CF memory card until it is fully seated. The label on the memory card should face the front of the camera and the edge with the holes has to mate with the connector inside the camera.

### Note: Using a new CF memory card

A new CF memory card should be formatted for use with the COOLPIX995 camera body. The CF memory card supplied with the camera is already formatted.

### Removing the CF memory card

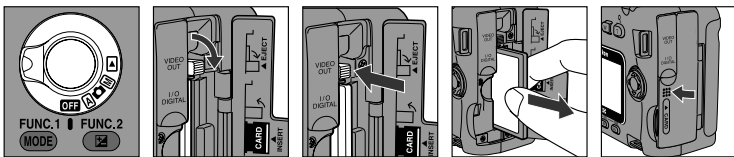

### Note: Inserting/removing the CF memory card

Make sure that the Mode dial is set to **OFF**.

3 Set the Mode dial to **A** and check the battery power (p. 31).

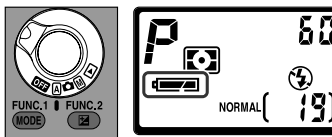

• When lights up or flashes, charge the supplied battery using the supplied battery charger.

### Date/time setting

The date and time for your country or location should be set before use. The correct date and time at which each picture is taken is then automatically recorded with the image and can be checked on the camera monitor or computer (after transfer). See "Setting Date/Time" on p. 34.

### Image quality and Image size

Press the **QUAL** button to choose between the four types of Image quality (compression ratio) (p. 58) and rotate the Command dial while pressing the **QUAL** button to select one of the six types of Image size (p. 59).



\* **HI** Image quality cannot be selected in **A** mode.

4 Center the subject in the Monitor or Viewfinder and compose your picture (p. 46).

• Use the Zoom buttons to frame your subject in the Monitor or Viewfinder.  
 • The button zooms the camera out, reducing magnification and increasing the field of view. The button zooms the camera in.

**5** Press the Shutter release button lightly to focus on the subject by using autofocus. (p. 48).

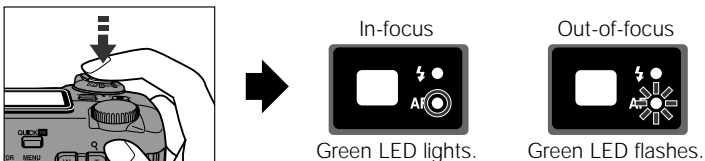

- The Green LED lights when the subject is in focus and flashes rapidly when the camera cannot autofocus.

**6** Use the built-in Speedlight if there is insufficient light to illuminate the subject (p. 50). This condition is indicated by the Red LED flashing rapidly when the Shutter release button is half-pressed.

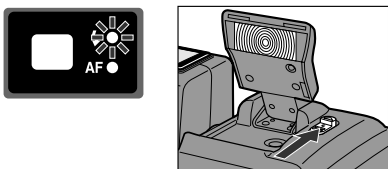

- Slide the Speedlight lock-release lever to release the built-in Speedlight.

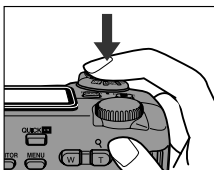

**7** Slowly and fully depress the Shutter release button to take the picture (p. 49).

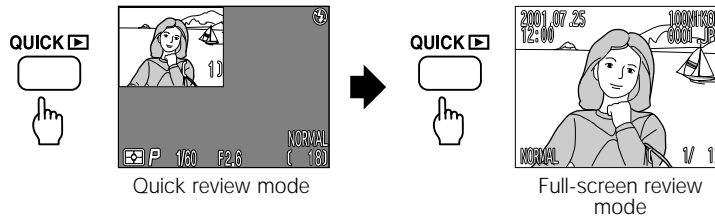

- A single beep sound indicates that the shutter has been released.

**8** Press the QUICK  button to check the picture immediately (p. 51).



- Photographs stored on the CF memory card can be reviewed using the  button. Press the  button to view the image in the top left corner of the Monitor.
- Press the  button again to see the image full screen.
- Use the Zoom button to enlarge the image and use the Multi selector to scroll to hidden parts of the picture.

**9** Set the Mode dial to **OFF** when you have finished taking photographs.

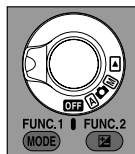

### Deleting images

You can delete the image in the Full-screen review mode. See step 6 of "Basic Operation (Auto mode)" on p. 52.

# Menu Guide: Shooting Mode

**Shooting Menu 1**

Press MENU button to select.



Press the Multi selector to switch between Shooting menu 1 and 2.

**Shooting Menu 2**



If the Symbol appears to the right of a menu item you can also select an option by rotating the Command dial.



<p><b>WHITE BALANCE</b> Select white balance in accordance with lighting conditions (p. 95)</p>	<p><b>WHITE BALANCE</b> </p> <ul style="list-style-type: none"> <li>A Auto</li> <li>White Bal Preset</li> <li>Fine</li> <li>Incandescent</li> <li>Fluorescent</li> <li>Cloudy</li> <li>Speedlight</li> </ul>
<p><b>METERING</b> Select metering mode (p. 97)</p>	<p><b>METERING</b> </p> <ul style="list-style-type: none"> <li>Matrix</li> <li>Spot</li> <li>Center-Weighted</li> <li>Spot AF Area</li> </ul>
<p><b>CONTINUOUS</b> Select Shooting mode (p. 99)</p>	<p><b>CONTINUOUS</b> </p> <ul style="list-style-type: none"> <li>Single</li> <li>Continuous</li> <li>Multi-shot 16</li> <li>VGA Sequence</li> <li>Ultra HS</li> <li>Movie</li> </ul>
<p><b>BEST SHOT SELECTOR</b> Turn best shot selection on or off (p. 102)</p>	<p><b>BEST SHOT SELECTOR</b> </p> <ul style="list-style-type: none"> <li>BSS Off</li> <li>BSS On</li> </ul>
<p><b>IMAGE ADJUSTMENT</b> Adjust brightness or contrast of image (p. 104)</p>	<p><b>IMAGE ADJUSTMENT</b> </p> <ul style="list-style-type: none"> <li>A AUTO</li> <li>Normal</li> <li>+ More Contrast</li> <li>- Less Contrast</li> <li>Lighten Image</li> <li>Darken Image</li> </ul>
<p><b>SATURATION CONTROL</b> Adjust the saturation to control the strength of color, or to select black and white photographs (p. 105)</p>	<p><b>SATURATION CONTROL</b> </p> <ul style="list-style-type: none"> <li>+1 Maximum</li> <li>0 Normal</li> <li>-1 Moderate</li> <li>-2 Minimum</li> <li>B&amp;W</li> </ul>
<p><b>LENS</b> Select type of optional lens converter or Slide Copy Adapter (p. 106)</p>	<p><b>LENS</b> </p> <ul style="list-style-type: none"> <li>Normal</li> <li>Wide Adapter</li> <li>Telephoto 1</li> <li>Telephoto 2</li> <li>Fisheye 1</li> <li>Fisheye 2</li> <li>Slide Copy Adptr</li> <li>Telephoto 2</li> </ul>

<p><b>USER SETTING</b> Select User Setting 1/2/3 (p. 108)</p>	<p><b>USER SETTING</b> </p> <ul style="list-style-type: none"> <li>1 User setting number 1</li> <li>2 User setting number 2</li> <li>3 User setting number 3</li> </ul>
<p><b>EXPOSURE OPTIONS</b> Turn AE Lock and Auto Bracketting on or off, set exposure compensation (p. 109)</p>	<p><b>EXPOSURE OPTIONS</b> </p> <ul style="list-style-type: none"> <li>AE Lock</li> <li>EXP. +/-</li> <li>Exposure mode</li> <li>Off/On/Reset</li> <li>+2.0 to -2.0</li> <li>P/S/A/M (A/M (S))</li> </ul>
<p><b>FOCUS OPTIONS</b> Select AF Area, change Autofocus mode, confirm focus or change distance units (p. 111)</p>	<p><b>FOCUS OPTIONS</b> </p> <ul style="list-style-type: none"> <li>AF Area Mode</li> <li>Auto-Focus Mode</li> <li>Focus Confirmation</li> <li>Distance Units</li> <li>Auto/Manual/Off</li> <li>Continuous AF/Single AF</li> <li>MF/On/Off</li> <li>m/ft</li> </ul>
<p><b>IMAGE SHARPENING</b> Select level of image sharpening to be performed (p. 114)</p>	<p><b>IMAGE SHARPENING</b> </p> <ul style="list-style-type: none"> <li>A Auto</li> <li>High</li> <li>Normal</li> <li>Low</li> <li>Off</li> <li>Off</li> </ul>
<p><b>AUTO BRACKETING</b> Set Auto Bracketting (on or off) or White Balance Bracketting (p. 115)</p>	<p><b>AUTO BRACKETING</b> </p> <ul style="list-style-type: none"> <li>Off</li> <li>On</li> <li>WB Bracketting</li> <li>3, ±0.3/3, ±0.7/3, ±1.0/5, ±0.7/5, ±1.0</li> </ul>
<p><b>NOISE REDUCTION</b> Turn Noise Reduction on or off (p. 117)</p>	<p><b>NOISE REDUCTION</b> </p> <ul style="list-style-type: none"> <li>On</li> <li>Off</li> </ul>
<p><b>RESET ALL</b> Reset all settings to default values (p. 118)</p>	<p><b>RESET ALL</b> </p> <ul style="list-style-type: none"> <li>Reset all settings to default values</li> <li>No Reset</li> </ul>

Before Using the Camera

# Menu Guide: Shooting Mode

**SET-UP 1**  
 



**SET-UP 1**  
 



Press MENU button and Multi selector to select.





Press the Multi selector to switch between SET-UP menu 1 and 2.









**SET-UP 2**  
 

**SET-UP 2**  
 

Press MENU button and Multi selector to select.

**SET-UP**  
 

**SET-UP**  
 

SET-UP item with   can also be set in   Shooting mode.

**FOLDERS**  

Create new folders, rename or delete existing folders, choose folder for recording (p. 122)

**Options** ▶ New/Rename/Delete

**NIKON**  
(Folder name)

**MONITOR OPTIONS**  

Adjust monitor brightness and hue (p. 125)







**Display Mode** ▶ Monitor On/Review Only/Preview Only/Monitor Off



**Brightness** ▶ (5 level adjustable)



**Hue** ▶ (11 level adjustable)



**CONTROLS**  

Set camera to "remember" settings in effect when camera is turned off; assign functions to FUNC. 1/ FUNC. 2 buttons (p. 130)

**Memorize** ▶  /  /  / Mode/  /  /  /

**Func. 1** ▶ Mode/  /  /  /

**Func. 2** ▶ White Balance/  /  /  / Metering



**ZOOM OPTIONS**  

Turn Digital Tele and Fixed Aperture on or off, set start-up position (p. 132)

**Digital Tele** ▶ On/Off

**Startup Position** ▶ Last Position/Wide/Tele

**Fixed Aperture** ▶ Off/On

**AUTO OFF**  



Set time delay for Auto Power Off function (p. 127)

**30 S**

**1 M**

**5 M**

**30 M**



**SEQ. NUMBERS**  

Reset Seq. Number function; turn file numbering on or off (p. 128)

**On**

**Off**



**Reset**

**CF CARD FORMAT**  

Format CF memory card (p. 129)

**WARNING!**  
All images will be deleted!

**No/Format**

**SPEEDLIGHT OPT.**  

Set flash output; turn internal flash and shot confirmation lamp on or off (p. 133)

**Variable Power** ▶ +2.0 to -2.0

**Int Flash Off** ▶ Off/On



**Shot Confirm Lamp** ▶ Off/On

**SHUTTER SOUND**  

Turn camera sound on or off (p. 127)

**On**



**Off**

**DATE**  

Set camera's data and time (p. 129)

**Year/Month/Day/Hour/Minute**

**Display order**

**INFO. TXT**  

Turns recording of text data on or off (p. 134)

**Off**

**On**

**VIDEO MODE**  

Select video standard for your region for playback on television screen (p. 135)

**NTSC**

**PAL**

**LANGUAGE**  

Select language for menu and message display (p. 135)

**D**

**E**

**F**

**J**

**S**

**DISABLE DELETE**  

Disable/enable deletion of all image files at a single command (p. 135)

**On**

**Off**

Before Using the Camera

# Menu Guide: Playback Mode



## Playback Menu







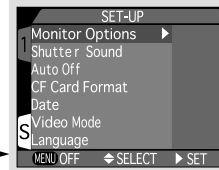













 Press MENU button to select.







Press the Multi selector to switch between Playback menu and SET-UP menu.



## SET-UP

	<b>DELETE</b> Delete selected images using thumbnail display; delete all images or the settings of Auto Transfer and Print-order files (p. 138)	 Selected Images  All Images  Reset Trns/Print
	<b>FOLDERS</b> Create new folders, rename or delete existing folders; choose folder for recording (p. 140)	 Options New/Rename/Delete  All Folders  NIKON  (Folder name)
	<b>SLIDE SHOW</b> Start slide show of images contained in single folder; set frame interval from 2s/3s/5s/10s (p. 140)	 Start  Frame Intvl 2S/3S/5S/10S
	<b>PROTECT</b> Protect selected images using thumbnail display (p. 142)	 (Select image and set Protect)
	<b>HIDE IMAGE</b> Hide selected images using thumbnail display (p. 143)	 (Select image and set Hide Image)
	<b>PRINT SET</b> Select images for printing using thumbnail display (p. 144)	 (Select image and set number of prints)
	<b>AUTO TRANSFER</b> Automatically transfer selected images or all images to a connected computer (p. 146)	 Selected Photos  All Photos

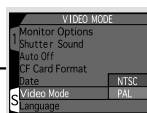
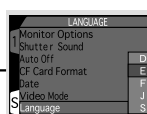
	<b>MONITOR OPTIONS</b> Adjust monitor brightness and hue (p. 150)	Brightness (5 level adjustable) Hue (11 level adjustable)
	<b>SHUTTER SOUND</b> Turn camera sound on or off (p. 150)	On Off
	<b>AUTO OFF</b> Set time delay for Auto-Off function (p. 150)	30 S 1 M 5 M 30 M
	<b>CF CARD FORMAT</b> Format CF memory card (p. 151)	<b>WARNING!</b> All images will be deleted! No/Format
	<b>DATE</b> Set camera's data and time (p. 151)	Year/Month/Day/Hour/Minute Display order
	<b>VIDEO MODE</b> Select video standard for your region for playback on television screen (p. 151)	NTSC PAL
	<b>LANGUAGE</b> Select language for menu and message display (p. 152)	D E F J S

Before Using the Camera

# PREPARATION

This section introduces preparations necessary before using the camera.

## Check list

Check that all the components listed below are included in the package. If any components are missing, contact the retailer where you purchased your COOLPIX995.

1. Nikon COOLPIX995 Digital Camera
2. Strap
3. Li-ion Rechargeable Battery
4. Battery Charger with AC power cord
5. Video Cable
6. CompactFlash™ (CF) Memory Card
7. USB Cable for connection to computer.
8. Lens cap
9. Nikon View 4 CD-ROM (contains Nikon View 4 and bundled software)
10. Instruction manual for COOLPIX995
11. CD-ROM instruction manual for Nikon View 4
12. "Open Me First!" Envelope – your path to After Sales Support and Service.

# Installing Battery

The camera requires either the supplied Li-ion Rechargeable Battery or a 2CR5 (DL245) 6V lithium battery (available separately). Make sure to check the battery power when a new battery is installed or before shooting.

**1** Turn the Mode dial (p. 44) to **OFF** and open the battery chamber cover.

- Slide the battery chamber cover latch toward  to open the cover.

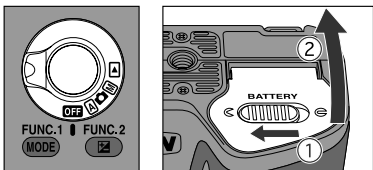

**2** Insert the battery with the  $\oplus$  and  $\ominus$  ends positioned as indicated inside the battery chamber, then firmly close the cover.

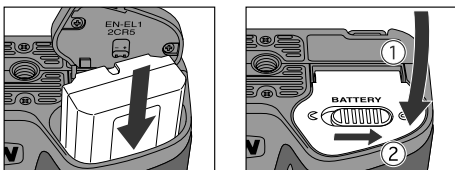

- Slide the battery chamber cover latch toward  to lock the cover.

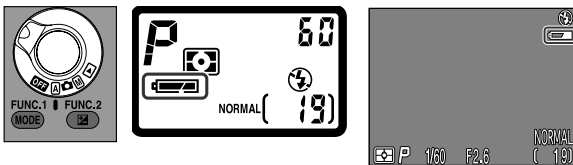

**3** Set the Mode dial to  and check the battery power on the Control panel or Monitor.



\* Battery power indication only displayed in the Monitor when there is insufficient battery power.



 lights up (on Control panel only)	Sufficient battery power
 lights up	Battery power is low—please recharge or change battery.
 flashes	Battery is exhausted—recharge or change battery as soon as possible.

- All the camera functions are disabled when the battery is completely exhausted.
- The CF memory card will retain images regardless of the condition of the camera battery.
- Battery power can be conserved and the available number of shots per battery increased by turning off the Monitor (p. 46) and using the Viewfinder.

## Supplied Li-ion Rechargeable Battery

The supplied Li-ion Rechargeable Battery is not fully charged at shipment. We recommend that you charge the battery before first use. Please see the instruction manual supplied with the charger for details.

## Precautions on battery use and handling

- Be sure to follow the warnings and cautions in "For Your Safety" on pp. 3-9 when installing/handling the battery.
- The battery cannot be replaced when a tripod or optional bracket is attached.
- Due to the characteristics of the battery, the battery power indicator  may briefly show when the exhausted battery is reinstalled.
- The flashing low battery indication  does not change to full battery indication  (steady) when the AC Adapter is connected. To reset the indicator, turn the power off and then on again.

## Power sources

We recommend use of the supplied Li-ion Rechargeable Battery. This battery can be charged with the supplied battery charger. Use of the optional accessory AC Adapter/Battery Charger EH-21 (p. 163) is recommended if the camera is being used for extended periods of time.



# Selecting a Language

The language in which menus and messages are displayed can be selected using the Language sub-menu.

1 Turn the Mode dial to .

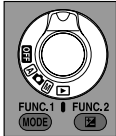

- The Language can also be set using the SET-UP menu in the  Shooting mode.





2 Press the MENU button so the Playback menu is displayed.

- The appearance of the menu will vary depending on the language currently selected.



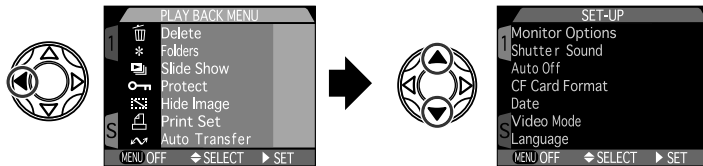

3 Press  on the Multi selector to highlight the tab on the left and press  to highlight the "S" tab.



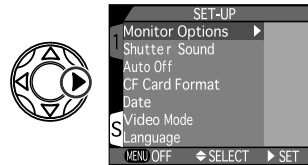

4 Press  on the Multi selector to display the SET-UP menu.

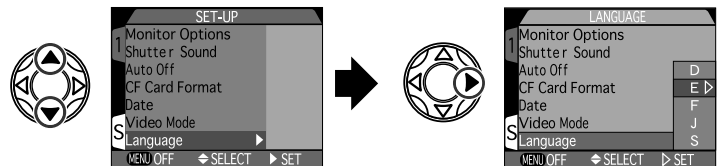

5 Press  on the Multi selector to highlight the "Language" sub-menu and press  to select "Language".



6 Press  on the Multi selector to highlight "D", "E", "F", "J" or "S" and press  to select.

- When the Language is set, the display returns to the SET-UP menu.

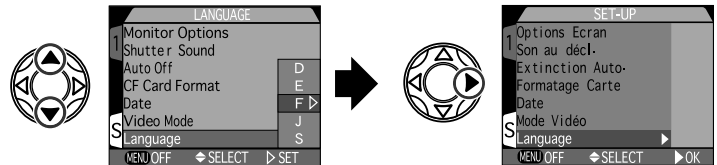

The languages available in the "Language" sub-menu are:

- D: German (Deutsch)
- E: English
- F: French (Français)
- J: Japanese
- S: Spanish (Español)

# Setting Date/Time

The date and time for your country or location should be set before use.

- 1 Set the Mode dial to and press the MENU button to display the SET-UP menu.

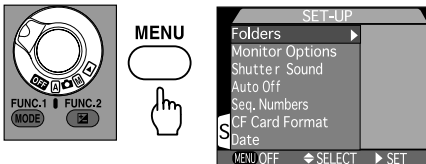

- 2 Select "Date" in the SET-UP menu.

- Press  $\blacktriangle/\blacktriangledown$  on the Multi selector (p. 44) to highlight **Date** and press  $\blacktriangleright$  to display date/time setting. The year display flashes.

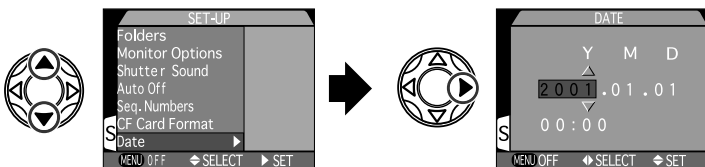

- 3 Set year, month, day, hour and minute.

- Pressing  $\blacktriangle$  on the Multi selector increases the number and pressing  $\blacktriangledown$  decreases the number. After setting a number, pressing  $\blacktriangleright$  moves the selection on.

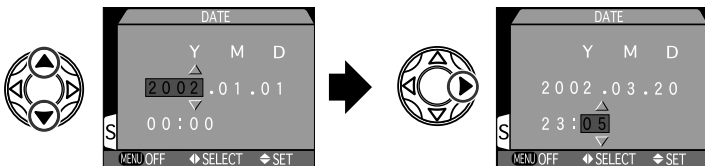

**Year** ↔ **Month** ↔ **Day** ↔ **Hour** ↔ **Minute** ↔ **Date display sequence**

- The year display can be set between 1970 to 2037.

- 4 Set the date display order.

- Press  $\blacktriangle/\blacktriangledown$  on the Multi selector to change the date display order as followings.

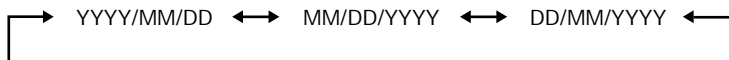
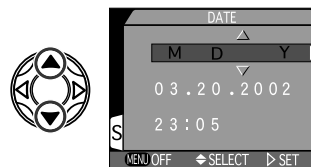

- 5 Complete the date and time setting.

- Press  $\blacktriangleright$  on the Multi selector after selecting the desired date display order to complete date/time setting. When the date display order is set, the clock starts and the display returns to the SET-UP menu.

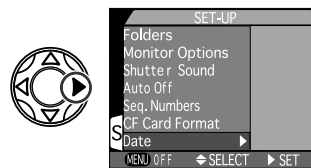

## Printing image date/time with a photo

When date and time are set, image date and time are recorded with the image data (inside the image file) and can be displayed when the image is played back (p. 74). The image date and time can be printed with the photo (p. 144).

## Backup battery of the clock

The clock-calendar is powered by a separate rechargeable battery, which is charged as necessary when the main battery is installed. If the camera has been stored with the main battery removed for a long period of time, the clock may need to be reset. Once the main battery has been reinserted, the clock battery will recharge in several hours, during which time the main battery should be left in the camera.

# Inserting CF Memory Card

The COOLPIX995 uses a CompactFlash™ (CF) memory card to store images and movies.

Use a Nikon CF memory cards or other recommended memory card. See p. 163 and the instruction manual of the CF memory card for notes on using the card.

## Inserting the CF Memory Card

1 Turn the Mode dial to **OFF**, open the card slot cover, and gently insert the CF memory card until it is fully seated. The label on the CF memory card should face the front of the camera and the edge with the holes has to mate with the connector inside the camera.

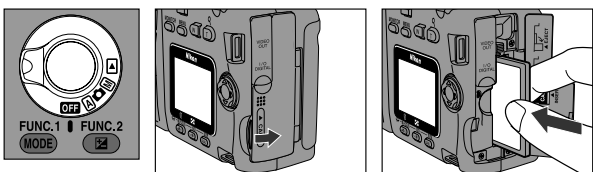

### Note: Inserting the CF memory card

- Make sure that the Mode dial is set to **OFF** when inserting the CF memory card.

2 Return the eject lever to its original position after fully inserting the CF memory card and make sure to completely close the card slot cover.

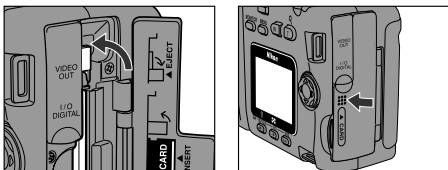

## Removing the Memory Card

1 Turn the Mode dial to **OFF**, open the card slot cover, fold out the eject lever and press it in to release the CF memory card.

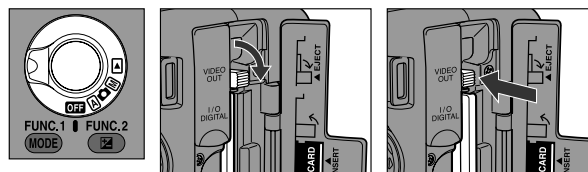

### Notes: Removing the CF memory card

- Make sure that the Mode dial is set to **OFF** when removing the CF memory card.
- Note that the CF memory card may become warm during extended camera use.

2 Grasp the CF memory card with your fingertips and pull gently to extract it. Then close the card slot cover.

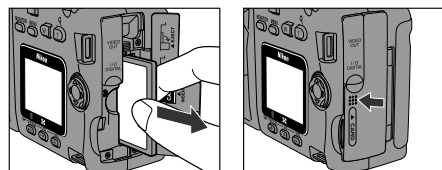

# Formatting CF Memory Cards



CF memory cards must be formatted before being used with the COOLPIX995. Note that the CF memory card supplied with your camera has already been formatted.

## Note: Formatting CF memory cards

Note that when a CF memory card is formatted, the entire contents of the card are permanently deleted.

1 Insert the CF memory card into the COOLPIX995 (p. 36).

2 Turn the Mode dial to .

- CF memory cards can also be formatted in  or  mode.

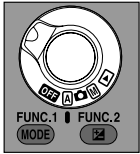

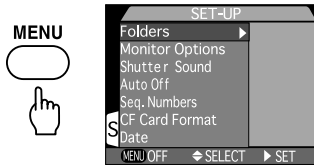

3 Press the MENU button.

- The SET-UP menu is displayed in the Monitor.



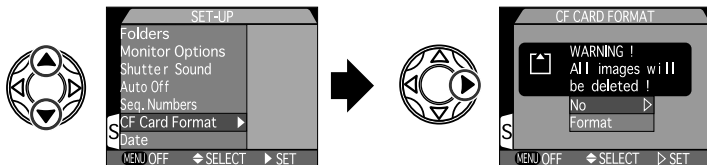

4 Select "CF Card Format".

- Press / on the Multi selector to highlight **CF Card Format** and select it by pressing .



5 Select "Format".

- Press / on the Multi selector to highlight **Format** and select it by pressing . Formatting is started, **FORMATTING** is displayed and then the Monitor returns to the SET-UP menu.

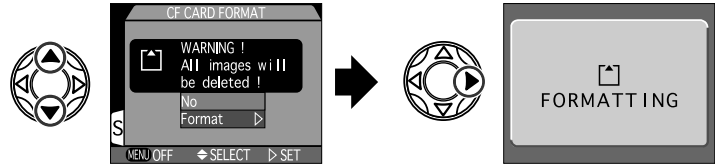

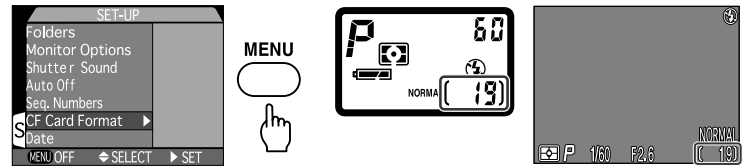

6 Press  button to complete the operation.

- After formatting, confirm the available number of frames in the Control panel or Monitor (p. 60).



## Aborting format

It is possible to abort the **Format** selection by pressing the MENU button to immediately exit the menu. Alternatively, select **No** with / on the Multi selector and return to the SET-UP menu by pressing .

## Note: Formatting

Selecting **Format** by pressing  on the Multi selector starts formatting immediately. At this point formatting cannot be stopped. Formatting permanently deletes all the data recorded on the CF memory card. Do not remove the CF memory card during formatting.

# Strap and Lens Cap

## Attaching strap

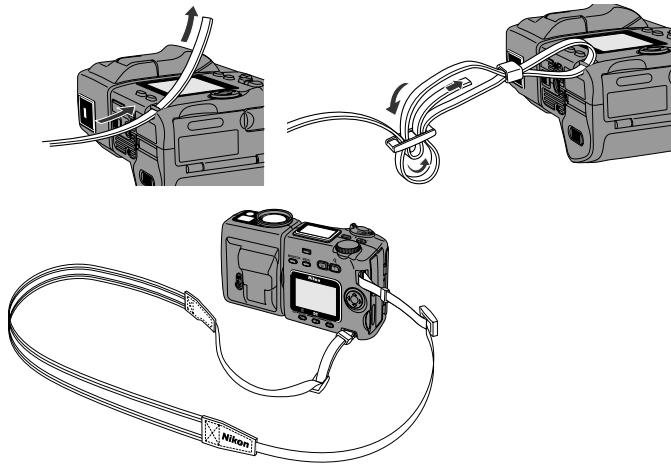

- Attach the strap as illustrated.

## Lens cap

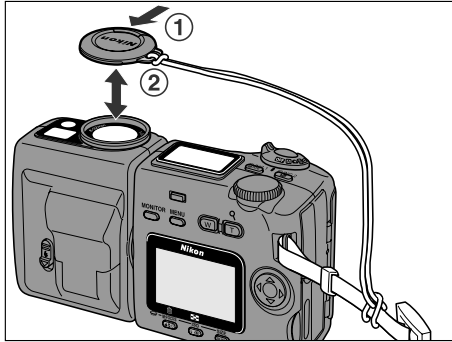

- Press the latch on the lens cap to attach/detach it.
- Since the lens cap can easily be misplaced, we recommend attaching it to the strap with the supplied cord.

# Useful Advice on COOLPIX Camera Techniques

# Holding the Camera

To reduce blurring caused by camera shake, hold the camera steadily in both hands and press the Shutter release button slowly and gently. Photographs can be framed in the Monitor or the Viewfinder.

## Check point

The lens section of this camera rotates so the subject can be seen easily on the Monitor and/or Viewfinder. Rotate the camera so that it can be held securely.

## Frame photographs in the Monitor

- When you are using Macro close-up (p. 61).
- When you are using Digital zoom (p. 63).
- When you are using a lens converter (p. 106, 162)
- When Image size is set to 3:2 (p. 59).
- When you want direct confirmation of camera settings or the view through the lens.

## Using the Swivel

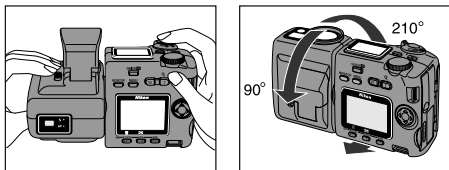

- The unique swivel design of the camera allows you to position the lens toward the subject while having the Monitor in a convenient position for checking. With the Monitor facing toward you, the lens section can be tilted 210° forwards and 90° backward. There is a Swivel lock lever (p. 106) on the base of the camera which, when set, prevents the lens from tilting down if a heavy converter lens accessory is fitted.
- Note that bright objects such as lights may cause a vertical white line to appear in the Monitor. This is not a malfunction and does not normally appear on the image.

## Self-portrait pictures

For convenient framing of self portraits, when the lens is rotated to face backwards, the display will invert so that it appears the correct way up.

# Holding the Camera/Pressing the Shutter Release Button

## Frame photographs in the Viewfinder

- When you want to save power by turning the Monitor off (p. 46).
- When bright ambient lighting conditions make it difficult to see the display in the Monitor.

## Diopter adjustment dial

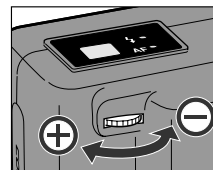

If the images in the Viewfinder appear blurred even when the subject is in focus, set the diopter adjustment for your particular eyesight by rotating the diopter adjustment dial so the autofocus target area frames in the Viewfinder can be seen clearly.

## Notes: Holding the camera

- Make sure not to let your finger, hair, the strap, power cord of the AC Adapter or video cable get in front of the lens or Speedlight.
- Make sure not to get your finger or clothing caught in the rotating part of the camera or cover while shooting.
- Do not look directly at the sun through the Viewfinder.
- The rotating lens section should be rotated slowly and within its range. (Approx. 270 degrees)

## Pressing the Shutter release button

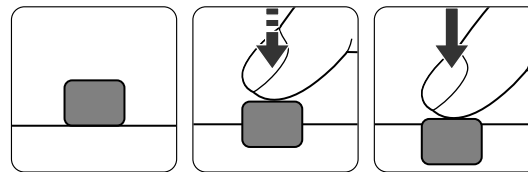

Before releasing shutter

Half press

Fully depressed



- Lightly pressing the Shutter release button and holding it halfway down activates the camera's exposure meter and autofocus.
- The focus is locked as long as the Shutter release button is kept lightly pressed (p. 48, 80). Pressing it fully all the way down releases the shutter.

## Note: Pressing the Shutter release button

Pressing the Shutter release button abruptly can result in picture blur. Make sure to press the Shutter release button slowly.

# Mode Dial and Multi Selector

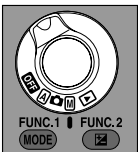
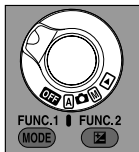

## Mode Dial

Use the Mode dial to select the Shooting mode ,  or Playback mode .



### : Shooting mode

There are two modes for taking pictures:

- In “” (Auto mode), the camera controls the exposure and other settings for simple, easy operation.
- In “” (Manual mode), camera settings such as exposure, white balance, image adjustment and sharpening are under full manual control.

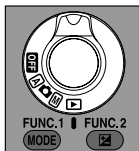













### : Playback mode

The Playback mode is for reviewing and managing your pictures. When the Mode dial is set to , images can be reviewed, deleted, played back in a slide show, marked for printing (DPOF) or can be protected from accidental deletion.

## Multi selector

When any camera menu is active, the Multi selector is used to move around the menus, making selections in both the up/down and left/right directions. When in Shooting mode, pressing the Multi selector allows the desired AF area to be chosen.

Position	Operation
	Press  /  to move vertically, selecting an item by highlighting it. Once an item has been highlighted further selections can be made by pressing  to move right and then, if applicable, pressing  /  to select the desired setting.
	<b>Selecting focus area (in  mode)</b> The camera has five autofocus target areas which can be activated in turn by using  ,  ,  or  on the Multi selector.

# Simple Shooting and Playback

Having mastered simple point operation and studied the section “Useful Advice on COOLPIX Camera Techniques”, we recommend that you read this section which explains some aspects of simple “Point and Shoot” photography in more detail.

Setting the Mode dial to  (auto mode)

automatically selects the most common exposure and image adjustment settings to ensure that the overall appearance of the picture is well balanced and correctly exposed.

- Other functions that are also preset are described below.

Image size (resolution)	➔ Full (2048 x 1536 pixels)
Image quality (JPEG compression ratio)	➔ Normal
Focus mode	➔ Continuous AF* (camera continuously focuses)
Flash mode	➔ Auto
Exposure Compensation	➔ None (0.0)
Monitor	➔ On*

\* When the Monitor is off, Single AF (the camera only focuses when the shutter is half-pressed) is selected.

# Basic Operation (Auto Mode)

## 1 Set the camera to Auto Mode (Set the Mode dial to )

- The camera beeps once when the power is turned on and standby operation starts. After a short pause, the camera is ready and the Viewfinder image is displayed on the Monitor.

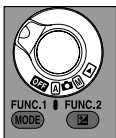

Control panel

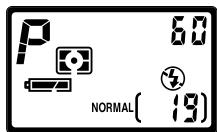

Monitor

- Individual function settings and the number of images that can be fitted on the CF memory card are displayed in the Control panel and Monitor.

### MONITOR button

- Pressing the MONITOR button changes the display in the following order (example in  mode):

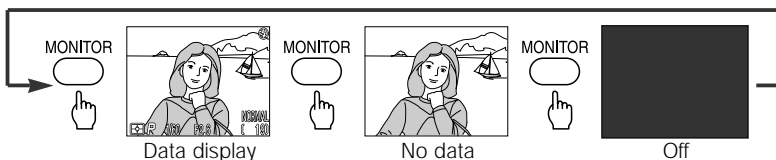

## 2 Compose your picture.

- Aim the lens at the subject and compose the picture in the Monitor or Viewfinder.

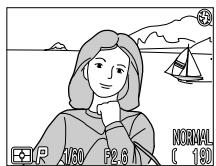

Monitor



Viewfinder

Parallax compensation marks for close-ups (Macro)

Autofocus target area

- When shooting in  mode, the camera will use the subject in the center of the picture as the focus target.

### Note: Composing using image in Viewfinder.

When composing a picture using the image in the Viewfinder, the actual image recorded is shifted slightly (due to a phenomenon known as parallax) compared to the image in the Viewfinder. Especially when shooting close-ups, the effect of parallax becomes more pronounced and the edges of the image seen in the Viewfinder image may not be included. Use of the Monitor is therefore recommended for close-up (Macro) shooting at distances of less than 90 cm/35 in. The parallax compensation marks in the Viewfinder indicate the compensation required when the subject to camera distance is 60 cm/24 in.

### Zoom button

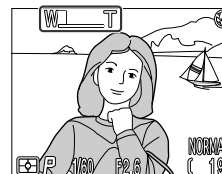

- Use the Zoom button to frame your subject in the Monitor or Viewfinder.

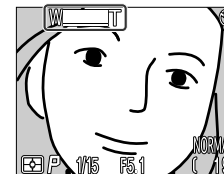
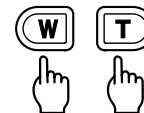

Wideangle



Telephoto

- To zoom out and see more in the Monitor or Viewfinder, press the  Zoom button. This sends the lens to the wideangle position. To zoom in and make the subject appear closer, press the  Zoom button.
- When the lens has zoomed to the full telephoto position with the Monitor turned on, the Digital zoom then allows a further magnification of up to 4x (p. 63).

### Note: Digital zoom

When using the Digital zoom, the image in the Viewfinder is different from the actual image recorded. Make sure to check the image in the Monitor.



# Basic Operation (Auto Mode)—continued

3 Lightly press the Shutter release button and confirm the focus.

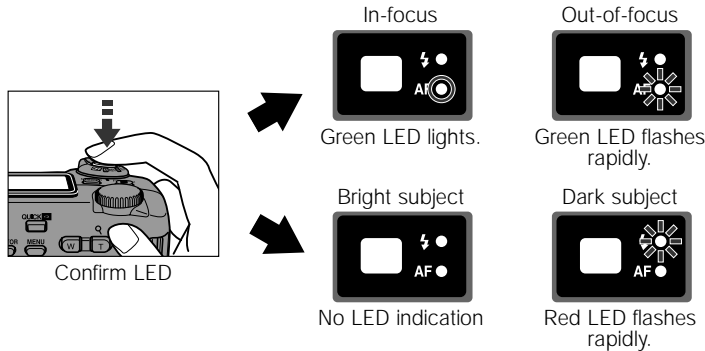

### Note: Continuous AF

When the Monitor is on, the camera continues to attempt to focus (Continuous AF, p. 62). The shutter can be released without focus being achieved. Check the focus status of the image in the Monitor before releasing the shutter.

### Focus Lock

When the subject is in focus while you are lightly pressing the Shutter release button, the focus is locked and the Green LED lights up without flashing. When the main subject is not centered in the frame, focus on the subject, lock focus, then recompose as you like while lightly pressing the Shutter release button. In Focus Lock, do not change the distance between the camera and subject when changing the composition.

4 Gently depress the Shutter release button.

- The shutter is released when the Shutter release button is fully depressed, the camera beeps once (p. 127) and the picture is taken.

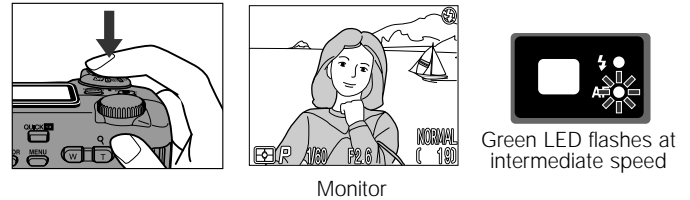

- Immediately after a picture is taken, the Green LED flashes and (Quick delete) and (pause, p. 85) are briefly displayed in the Monitor after which the Monitor will return to normal and the next shot can be taken.
- It is normally possible to take a picture when the shot is still being displayed in the Monitor. Lightly pressing the Shutter release button resets the Monitor to normal display and subsequent shots are possible unless (Wait) is displayed. The number of shots that can be taken may vary, depending on the Image size and Image quality (p. 58).

Image size	Image quality	Number of shots that can be taken
FULL	NORMAL	4
VGA	BASIC	77

- is displayed on the Monitor while image is being recorded on the CF memory card.

### Note: Recording on CF Memory Cards

The Green LED flashing at intermediate speed indicates that the image is being written to the CF memory card. Do not remove the card, battery or AC Adapter until the Green LED has gone out, or image data may be damaged or not recorded.

# Basic Operation (Auto Mode)—continued

## Built-in Speedlight

Use the built-in Speedlight if there is insufficient light to illuminate the subject. This condition is indicated by the Red LED flashing rapidly when the Shutter release button is half-pressed.

### To use the Speedlight

- Slide the Speedlight lock-release lever to release the built-in Speedlight.

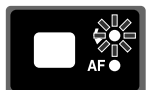
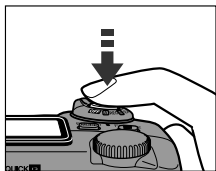

Red LED flashes rapidly.

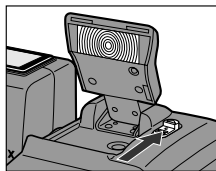

- Confirm the Red LED is steady, then gently depress the Shutter release button fully to take the picture with the built-in Speedlight.



Red LED steady.

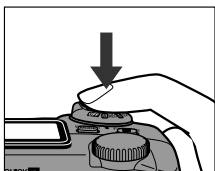

### Note: Using built-in Speedlight

Note that the built-in Speedlight may become warm during extended Speedlight use.

- Press the QUICK button to check the image immediately after shooting.

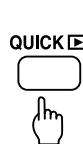

Quick review mode

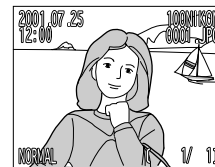

Full-screen review mode

- Each press of the QUICK button changes the display on the Monitor as follows:



- Press the Multi selector to choose the image to be displayed. To display the previous image frame continue to press ◀/▲. When the oldest frame is reached, pressing ◀/▲ changes the display to the most recent frame recorded. When the most recent frame is reached, pressing ▼/▶ changes the display to the oldest one.

### Check points:

- Lightly pressing the Shutter release button in either Quick review or Full-screen review resets the camera to normal Shooting mode and more shots can be taken.
- Recorded images can be played back in Full-frame playback (p. 74) by rotating the Mode dial to ▶.

**6** Press the Delete button in Full-screen review mode and select “Yes” with the Multi selector to delete a single image.

- Using the Multi selector choose the image to be deleted. Pressing the Delete button displays a confirmation dialog. Select Yes with the Multi selector. Pressing **▶** deletes the image and **DONE** is displayed.

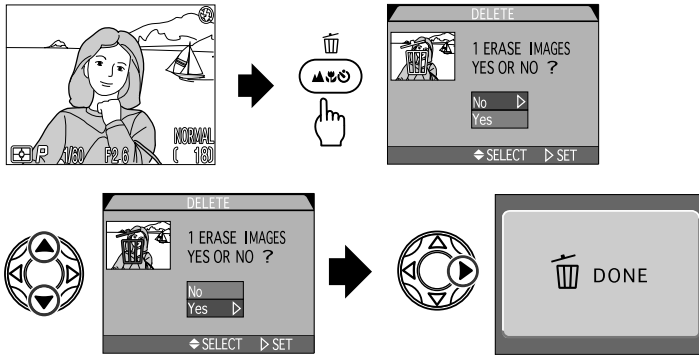

**Check point:**

Recorded images can also be deleted in **▶** mode (p. 77)

**7** Set the Mode dial to **OFF** when you have finished taking photographs.

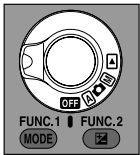

The Self-timer delays the shutter release for 3 or 10 seconds after the Shutter release button has been pressed to allow you to appear in your photograph. We recommend that you use a tripod or place the camera on a stable surface when using the Self-timer.

**1** Press the Focus mode button several times until **☺** appears in the Control panel and Monitor.

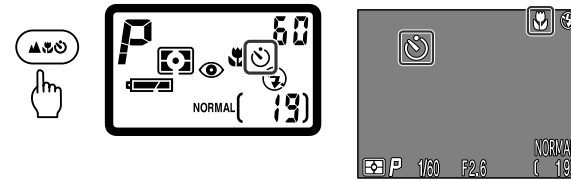

**2** Compose your picture, confirm focus and fully depress the Shutter release button.

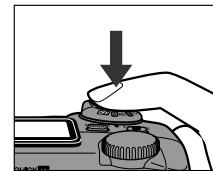

- Pressing the Shutter release button once activates a 10-second timer and twice activates a 3-second timer. (Press the Shutter release button twice to pause the 10 second Self-timer and once to pause the 3-second timer after activation of the timer.) The Self-timer lamp pulses for 1 second before the shutter is released and then lights steadily for the final 1 second. (The remaining time is visible as a count-down on the Monitor.) In **☺** Shooting mode, Self-timer operation using Manual focus (p. 81) is possible.
- To cancel Self-timer after activation of the timer, pause, then press the Focus mode button so **☺** disappears or else turn the power off.

**Check point**

Setting the Self-timer also activates Macro shooting mode, causing **🌸** to be displayed.

# Simple Playback Operations



Set the Mode dial to  to set the camera to Playback mode. In Playback mode, recorded images are visible on the Monitor. Multiple reduced size images can be viewed at once (Thumbnail Playback) or reviewed for deletion.

## Full-Frame Playback (See p. 74)

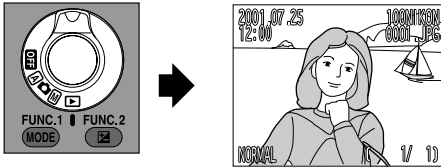
- 1 Set the Mode dial to .



- The most recent photograph is displayed in the Monitor. Press the Multi selector to select the image to display.

- 2 Press and hold the  Zoom button to see the image in closer detail. Press the  button to return to the original view. Use the Multi selector to see the hidden parts of the zoomed image.

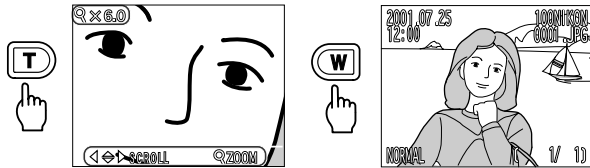

## Thumbnail Playback (See p. 76)

- 1 Press the Thumbnail () button once to display nine Thumbnail images, or twice to display four Thumbnail images. The Thumbnail image can be selected with the Multi selector and displayed Full-frame.

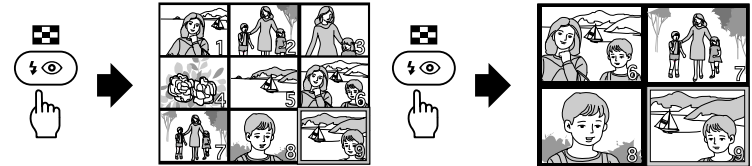

## Deleting Photographs in Full-Frame Playback (See p. 77)

- 1 Press the Delete () button in Full-frame playback.

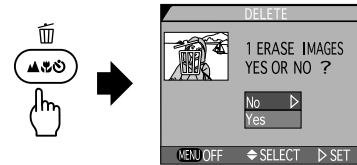

- The delete confirmation dialog is displayed. You can delete an image after confirming with the confirmation dialog.

## Other Functions

By connecting the camera to your TV set or a personal computer, you can view, edit or print out images taken with the COOLPIX995.

### Connect COOLPIX995 to a TV Set

By connecting the COOLPIX995 to a TV set, you can view your still pictures and movies on the television.

Connect the camera's video output terminal and the TV's video input terminal with the provided video cable.

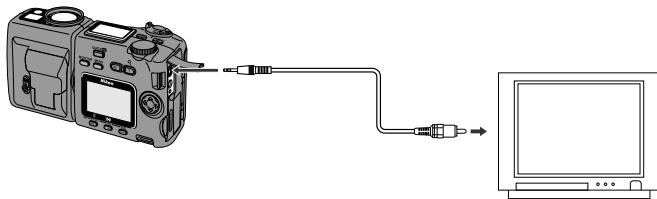

- To connect the COOLPIX995 to a TV set, see p.155.

### Connect COOLPIX995 to a Computer

By connecting the COOLPIX995 to a computer, you can download image data to your computer.

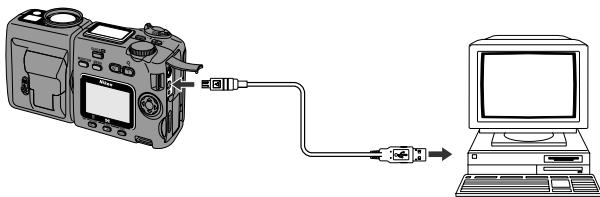

You can connect your camera directly to your computer via the supplied UC-E1 Universal Serial Bus (USB) cable. Nikon View 4 allows you to transfer, enlarge, save or print out images that have been downloaded to your computer.

To connect the camera to the computer you will need the supplied USB cable and Nikon View 4 CD-ROM.



- For details of operation, refer to the CD-ROM instruction manual for Nikon View 4.
- To connect the COOLPIX995 to a computer, see p. 156.

## Detailed Operations

This section describes detailed operations in ,  or  mode.

- Setting Image Quality and Size
- How Much Space is Left on My CF Memory Card—Confirming the Number of Exposures Remaining
- Selecting the Focus Mode
- Digital Zoom
- Setting the Exposure mode
- Setting the Exposure Compensation Value
- Adjusting Sensitivity
- Playback
- Deleting Photographs

In both or mode, one of the most important options for your pictures is the combination of Image quality setting (image compression ratio) and Image size setting that you select. There are four available Image quality settings and six Image size settings.

## Image Quality

To reduce memory requirements, images are compressed using JPEG compression. At higher compression ratios, the block pattern becomes more visible and there may be noticeable loss of detail. The actual effect depends on the size of the image when reproduced on a monitor or printer and on the type of subject.

To set the Image quality, press the QUAL (Image quality) button repeatedly until the desired Image quality setting is displayed.

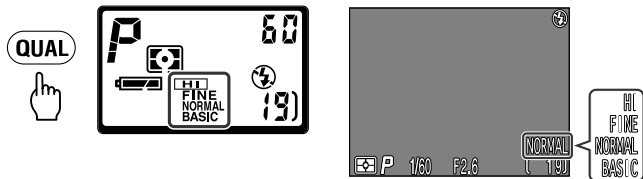

Setting	Compression ratio	File format	Application
<b>HI</b>	No compression	TIFF	Best-quality image, with no compression. Use when quality or authenticity is of paramount importance. (Available in <b>FULL</b> or <b>3:2</b> size in  mode only.)
<b>FINE</b>	Approx. 1/4	JPEG	Quality virtually identical to uncompressed <b>HI</b> mode; for use where image quality is important, for example when the image will be cropped and enlarged.
<b>NORMAL</b>	Approx. 1/8	JPEG	For use in most general situations where the image will not be significantly enlarged.
<b>BASIC</b>	Approx. 1/16	JPEG	For situations such as sending image data via E-mail where small file size is more important than Image quality.

### Check point

The selected Image quality and size settings remain in the camera's memory even when the power is turned off.

## Image Size

The Image size setting determines the maximum size at which the image can be printed. If the print size is too large, the individual pixels will be visible to the naked eye, giving the image a rough, uneven appearance. As a rule of thumb, for printing, about 200 pixels per inch are required. For display on a computer monitor, about 80 pixels per inch are recommended.

Rotate the Command dial while pressing the QUAL button until the desired Image size is displayed.

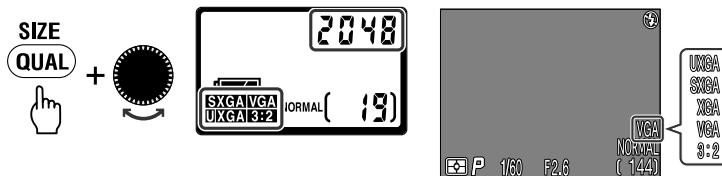

Setting	Size (pixels)	Application
<b>Full</b> (no indication)	2048 x 1536	For high quality prints of up to A4 without additional treatment.
<b>UXGA</b>	1600 x 1200	For printing at about A5 or large photo album size.
<b>SXGA</b>	1280 x 960	For smaller postcard-sized prints.
<b>XGA</b>	1024 x 768	For display on a 17-inch computer monitor or small prints, for example, to be included in a report.
<b>VGA</b>	640 x 480	For output on a 13-inch monitor, sending image data via E-mail, or posting a picture on an Internet homepage.
<b>3:2</b>	2048 x 1360	This format gives an aspect ratio which is of identical proportions to 35mm film. When <b>3:2</b> is selected, the top and bottom of the Monitor are cropped and the image frame becomes <b>3:2</b> . The Green LED pulses slowly.

Setting	Size (pixels)	Print size at 200dpi resolution
<b>Full</b>	2048 x 1536	Approx. 26 x 20 cm (10.2 x 7.9 in.)
<b>UXGA</b>	1600 x 1200	Approx. 20 x 15 cm (7.9 x 5.9 in.)
<b>SXGA</b>	1280 x 960	Approx. 16 x 12 cm (6.3 x 4.7 in.)
<b>XGA</b>	1024 x 768	Approx. 13 x 10 cm (5.1 x 3.9 in.)
<b>VGA</b>	640 x 480	Approx. 8 x 6 cm (3.1 x 2.4 in.)
<b>3:2</b>	2048 x 1360	Approx. 26 x 17 cm (10.2 x 6.7 in.)

The total number of images that can be saved on a CF memory card depends on the amount of space left in the CF memory card being used, and on the selected image quality and size.

To confirm the number of exposures remaining, check the Control panel and Monitor.



- The counter showing the number of exposures remaining decrements until “0” is displayed after which no further space is available. At this point, a warning indication **OUT OF MEMORY** is displayed in the Monitor.
- The approximate number of images that can be recorded is as follows. Memory card: 16MB [64MB] (Note that the numbers will vary significantly with the composition of the pictures due to the way that JPEG compression works.)

Image quality / Image size	Image quality			
	<b>HI</b>	FINE	NORMAL	BASIC
<b>FULL</b> (no indication)	1 [6]	10 [40]	19 [78]	37 [151]
<b>UXGA</b>	Not available	16 [65]	31 [126]	59 [236]
<b>SXGA</b>	Not available	24 [100]	47 [190]	86 [347]
<b>XGA</b>	Not available	37 [151]	69 [278]	121 [488]
<b>VGA</b>	Not available	86 [347]	144 [578]	229 [918]
<b>3:2</b>	1 [7]	11 [45]	22 [88]	42 [169]

**Notes: The number of exposures remaining**

- From time to time the number may not count down when shots are taken or deleted, particularly if the Image size is small.
- Even when “0” is shown, selecting another Image quality or size may enable more shots to be taken as there may be enough space for one or more images of a smaller size or higher compression ratio. By the same token, changing the Image quality or size may cause the frame counter to drop to “0”.
- No more shots can be taken when the image file names and folder numbers (p. 128) reach the maximum number (image file name: DSCN9999.JPG, folder number: 999). To continue, change the memory card or delete all of the image data on the card. Note that with the setting **Seq. Numbers On**, file names are assigned with the next highest number remaining in the memory card, so when a file with a high file name number is left in the memory, the maximum number, DSCN9999.JPG, will soon be reached and no more shots can be taken even if more memory is available on the card.

In or mode, three Focus modes and the Self-timer can be activated in turn by repeated presses of the Focus mode button. In mode, rotating the Command dial while pressing the Focus mode button initiates Manual focus and alters the manual focus distance (p. 81)

Press the Focus mode button repeatedly until the indication for the desired Focus mode or Self-timer is shown. (Note that an indication is not displayed in the Autofocus mode.)

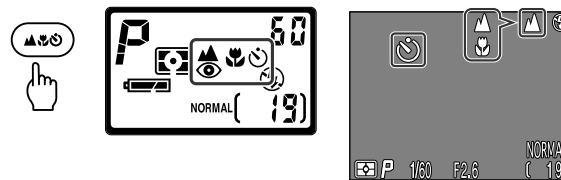

Focus mode	Indication	Characteristics
Autofocus mode	No indication	The easiest Focus mode, normal autofocus operation is suitable for almost any shooting situation including snapshots or portraits. Focus range is 30 cm (11.8 in.) to infinity.
Infinity mode		Select this mode to focus on distant subjects such as landscapes or buildings. The lens automatically moves to a position suitable for infinity focus and locks in position. <b>Flash Cancel</b> is automatically selected.
Macro Close-up mode		Select this mode when shooting close-ups of subjects such as flowers or insects. Focus distance is approx. 2cm (in middle Zoom position) to infinity. In the middle Zoom position,  in the Monitor is displayed in yellow to assist with optimum lens setting. Note that vignetting may occur when using with Speedlight illumination within the 70 cm (27.6 in.) focus distance.
Self-timer		Use this mode when you want to be in the photograph. The shutter is released 10 sec. after pressing the Shutter release button once or 3 sec. after pressing the button twice. The Self-timer lamp pulses until 1 sec. before shutter release and the lamp lights steadily for the final 1 sec. The remaining time is visible as a count-down on the Monitor. <ul style="list-style-type: none"> <li>• To cancel the Self-timer after initiation, pause the timer and then press the Focus mode button so  disappears, or turn the power off.</li> </ul>

**Controls** In mode, the selected Focus mode can be set to remain in memory even when the power is turned off; this setting can be changed with the **Memorize** setting.

## Check points

- The **Autofocus** mode is selected when the power is turned on.
- Selecting the **Self-timer** enables **Macro Close-up** mode and  is also displayed.

## Autofocus Options



There are several advanced options that may be employed when setting up the **Autofocus**. In particular, a difference will be noticed when the Monitor is on or off in **Autofocus** or **Macro Close-up** mode.

Monitor	AF mode	Characteristics
On*1	Continuous AF	Autofocus operation is activated continuously regardless of the operation of the Shutter release button. The focus is locked on when the Shutter release button is lightly pressed ( <b>Focus Lock</b> , p. 80) and the Green LED lights as confirmation of successful focus.
Off	Single AF	Autofocus operation is activated only when the Shutter release button is lightly pressed. Once focus is achieved, the Green LED lights and focus is locked (p. 80) as long as the Shutter release button is kept lightly pressed. Battery power can be conserved since the Monitor is not always on.

\* In  mode, the autofocus system when the Monitor is on can be changed to (Single AF) in the **Focus Options > Auto-Focus Mode** sub-menu in Shooting menu (p. 112).

## Autofocus Target Area Selection

Autofocus target area varies according to Shooting mode.

Shooting mode	Characteristics
	Focus is targeted on the center AF area. Place the main subject in the center AF area.
	All five AF areas in the Monitor are used when focusing. Normally, <b>AUTO</b> mode, where the camera automatically focuses using all five AF areas, is activated. In <b>MANUAL</b> mode, you can select just one of the AF areas, and when <b>Autofocus</b> is <b>Off</b> , only the center AF area is activated (p. 111).

With the Monitor turned on, **Digital zoom** electronically magnifies the center of the picture so that it fills the entire image. The subject can be magnified by up to 4X.

Keep pressing the  Zoom button for more than 2 sec. after the Zoom has reached the highest telephoto position. The Digital zoom function activates automatically and the image in the Monitor is zoomed by up to 4.0X. The Digital zoom magnification factor is displayed in the Monitor and the Green LED pulses slowly.

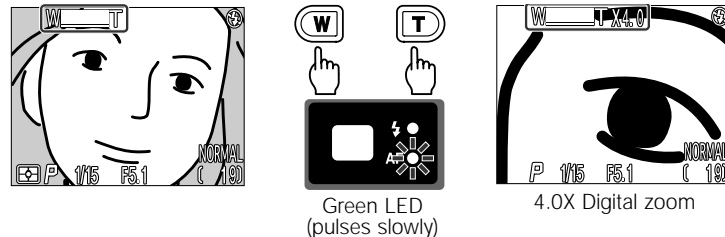

## Canceling Digital zoom

- Pressing the  button during **Digital zoom** lowers magnification and cancels **Digital zoom** after reaching the highest telephoto position of the optical Zoom.
- **Digital zoom** can also be canceled by turning camera power off.

## Check points

- The AF area remains at the center during **Digital zoom** even when another AF area is selected in the **Focus Options > AF Area Mode** sub-menu (without **Off** setting) (p. 111).
- Metering mode in **Digital zoom** is same as Center-Weighted Metering.

## Note: Digital zoom

- Resolution of the image deteriorates as you zoom in with the **Digital zoom** function.
- **Digital zoom** cannot be used in **HI Image quality**, **Multi-shot 16**, **Ultra HS**, **Movie** or **Black and White** mode.
- The **Digital zoom** function zooms into the middle part of the image in the Monitor and the actual recording area differs from the Viewfinder image. Make sure to confirm the image in the Monitor.

Detailed Operation



# Setting the Exposure mode

Shooting Mode

To create a variety of photographic treatments, various Exposure modes can be selected to achieve a desired effect. Four Exposure modes can be selected in Shooting mode.

Rotate the Command dial while pressing the MODE button so the desired Exposure mode is displayed.

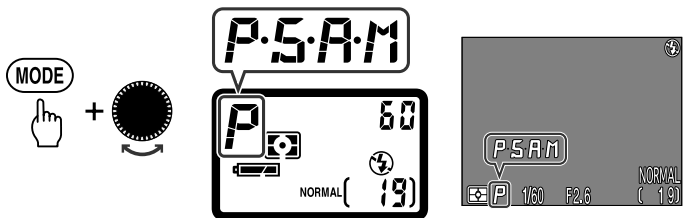

## Note: At slow shutter speed

The shutter speed indication in the Monitor appears in yellow when the shutter speed is slower than 1/4 sec. Noise may appear in the dark part of the frame in this case. This noise in the form randomly spaced bright-colored pixels can be reduced with the **Noise Reduction** mode (p. 117).

### Controls (P. 130)

- **Controls setting: Memorize**  
The selected Exposure mode is retained when the power is turned off; however, it can be set to become Programmed Auto when the power is turned on, by using the **Memorize** setting.
- **Controls setting: FUNC. 1**  
Various settings can be selected with the Exposure mode button.

## Note: Selecting fast shutter speed

When you want to shoot with a fast shutter speed, try shooting under as bright a condition as possible so that the aperture is stopped-down.

Exposure mode	Display	Shooting situation
Programmed Auto	<b>P</b>	Camera controls shutter speed and aperture automatically, while allowing you to choose other settings such as Flexible Program, Exposure Compensation (p. 71) or Auto Bracketing (p. 115).
Shutter-Priority Auto	<b>S</b>	You set desired shutter speed and the camera selects the correct aperture. Select a fast shutter speed for fast-moving subjects such as shooting an athlete, or a slow shutter speed to emphasize the motion effect.
Aperture-Priority Auto	<b>A</b>	You set desired aperture and the camera selects the correct shutter speed. Lets you determine depth of the in-focus area, so you can choose whether near or far subjects are in sharp focus when shooting landscapes, or whether the background is to be blurred as in a portrait.
Manual	<b>M</b>	Shutter speed and aperture are set manually. Suitable when you want full control over exposure, to create your own unique photographic effects.

## **P**: Programmed Auto

The camera automatically controls exposure—correct shutter speed (1 to 1/2300 sec.) and aperture combination— by determining the brightness of the subject. Programmed Auto Exposure mode is automatically set in mode.

### Flexible Program (only in and with Monitor on)

By rotating the Command dial in Programmed Auto and with the Monitor on, you can change the combination of shutter speed and aperture while maintaining correct exposure. With this function, you can shoot in Programmed Auto as though shooting in Shutter-Priority Auto or Aperture-Priority Auto. “\*” appears when Flexible Program is set. To cancel the Flexible Program, rotate the Command dial until “\*” disappears, change the Exposure mode or set the Mode dial to other than .

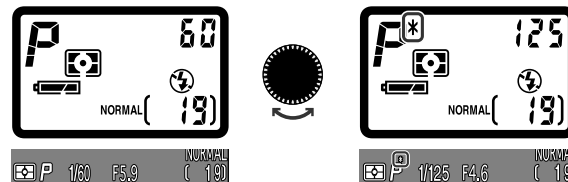

## S: Shutter-Priority Auto

Enables you to manually set the desired shutter speed (8-1/2000 sec.) in 1 EV steps; the camera automatically selects the proper aperture to provide correct exposure.

- Turning the Command dial after setting Shutter-Priority Auto Exposure mode changes the shutter speed as follows:

8' ↔ 4' ↔ 2' ↔ 1' ↔ 2 ↔ 4 ↔ 8 ↔ 15 ↔ 30 ↔ 60 ↔ 125 ↔ 250 ↔ 500 ↔ 1000 ↔ 2000

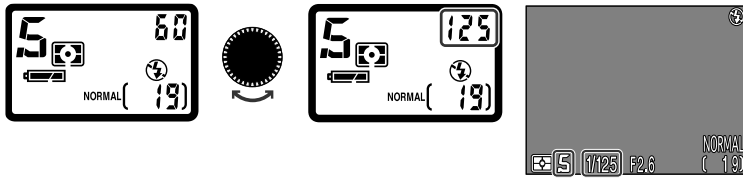

### Note: Control range of the camera

When the subject is too dark or too bright (beyond the control range of the camera) and the Shutter release button is lightly pressed, the selected shutter speed display pulses. To avoid motion blur or incorrect exposure, change the shutter speed setting.

## A: Aperture-Priority Auto

This mode enables you to choose the camera aperture (lens' minimum to maximum in 1/3 steps) manually. The camera automatically selects an appropriate shutter speed (8 to 1/2300 sec.) to ensure correct exposure.

- Turning the Command dial after setting Aperture-Priority Auto Exposure mode changes the aperture in 1/3 steps.

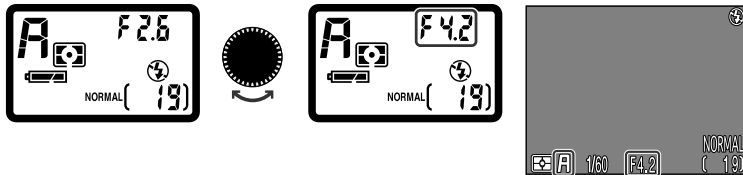

### Note: Control range of the camera

When the subject is too dark or too bright (beyond the control range of the camera) and the Shutter release button is lightly pressed, the selected aperture display pulses. If this occurs, change the aperture setting to avoid incorrect exposure.

## M: Manual

Enables you to set both shutter speed (8 sec. - 1/2000 sec. in 1 EV steps, plus long time exposure "BULB" up to 60 sec.) and aperture (lens' minimum to maximum in 1/3 steps) manually.

- 1 Set the Exposure mode to **M**, then take your finger off the MODE button. The aperture and shutter speed are displayed alternately in the Control panel as the MODE button is pressed repeatedly.
  - The aperture and shutter speed are highlighted in green in the Monitor.

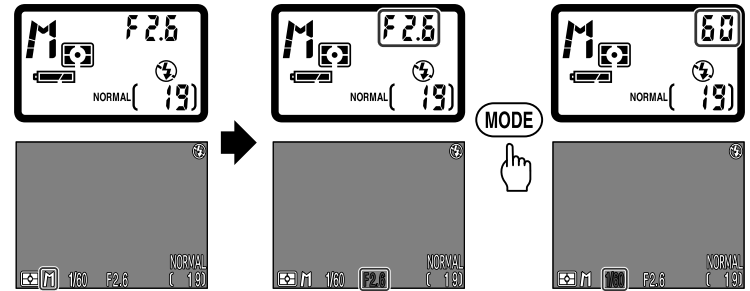

- 2 Confirm the Exposure condition in the Control panel or Exposure meter display in the Monitor and set the aperture and shutter speed by rotating the Command dial.
  - The difference between the selected exposure and the exposure measured by the camera is displayed in the Exposure condition and the Exposure meter display (except in long time exposure).

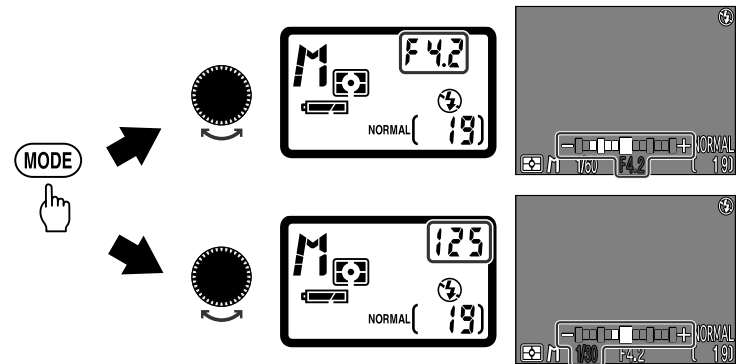

## Check point

If the shutter speed is displayed in red when 1/2000 sec. shutter speed is selected, stop-down aperture while confirming exposure on the Exposure meter in the Monitor.

Exposure status	Control panel	Monitor
Correct exposure		
1 EV under		
2 EV over		

## Long time (BULB) exposure (up to 60 sec.)

- Set the Exposure mode to **M**, and place the camera on a tripod or secure position, then rotate the Command dial to set the shutter speed indication to **bu 1b** (next after 8 sec.) to enable long time (BULB) exposure.

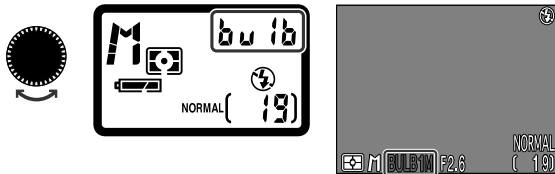

- Pressing the Shutter release button once opens the shutter up to 60 sec.

- BULB** can only be set when **Single** mode is selected in the **Continuous Shooting** menu (p. 99).
- The Speedlight is canceled if **BULB** exposure is set.
- During long-time exposure, selecting **Noise Reduction On** can reduce noise in the form randomly spaced bright-colored pixels in the recorded image (p. 117).

Four Flash modes are available for use in various flash shooting situations.

## Condition in which Flash mode can be set

Flash mode can only be set when the built-in Speedlight is raised. The Flash Cancel indication is displayed in the Control panel and Monitor when the built-in Speedlight is stowed.

- Slide the Speedlight release lever to release the built-in Speedlight.

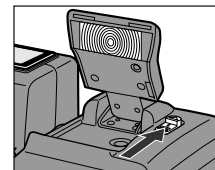

## Note: If flash does not fire

The Speedlight does not fire with Infinity focus (p. 61), in **Continuous Shooting** mode (other than **Single** mode) (p. 99), in **Best Shot Selector** mode (p. 102), **Lens** mode (p. 106) or **Int Flash Off** mode (p. 133) even when the built-in Speedlight is released.

- Press the Flash mode button repeatedly until the desired Flash mode appears.

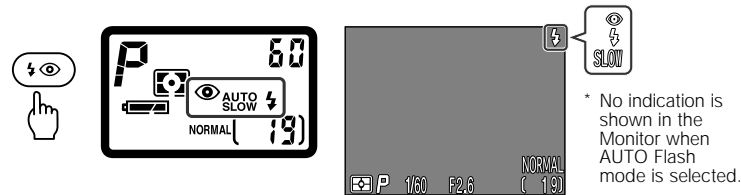

- If the Red LED is pulsing slowly when the Shutter release button is lightly pressed, the Speedlight is not fully charged and the shutter cannot be released. Wait until the Speedlight is fully charged and release the shutter again.

\* No indication is shown in the Monitor when **AUTO Flash** mode is selected.

Setting	Indication	Characteristics
AUTO flash	<b>AUTO</b>	Speedlight automatically fires when the subject is dark and the built-in Speedlight is released. Speedlight does not fire if the subject is adequately illuminated even when the built-in Speedlight is released.
AUTO flash with Red-eye reduction	<b>AUTO</b>	Reduces the “Red-eye effect” of flash photography. The Red-eye reduction lamp lights before the main flash.
Anytime flash		Select this mode to fire the Speedlight regardless of the subject’s brightness. Speedlight can also be effective in daylight when light is coming from behind the subject.
SLOW sync	<b>SLOW</b>	Both your main subject and background can be recorded naturally in twilight or nighttime. The shutter stays open for the same time as if Speedlight was not being used to illuminate the background. The Speedlight fires to give a clear defined foreground or subject image.

### Notes: SLOW Sync Flash

- Avoid camera shake since a slow shutter speed is often selected.
- The shutter speed indication in the Monitor appears in yellow when the shutter speed is slower than 1/4 sec. Noise may appear in the dark part of the frame in this case. This noise in the form randomly spaced bright-colored pixels can be reduced with the **Noise Reduction** setting (p. 117).

### Check points

- In mode, AUTO flash mode is automatically selected when the built-in Speedlight is released. The previously set Flash mode is selected in mode.
- Vignetting may occur with speedlight illumination where the subject to camera distance is less than 70 cm (27.6 in.).
- The Flash output of other Speedlights connected to the sync terminal is synchronized with the built-in Speedlight (p. 90).

**Controls** In mode, the selected Flash mode can be set to remain in the memory even when the power is turned off; this setting can be changed with the **Memorize** setting. (P. 130)

Exposure Compensation can be employed to deliberately offset the exposure from the measured value. Twelve Exposure Compensations from -2EV to +2EV in 1/3 steps can be set for various shooting purposes or situations.

Rotate the Command dial while pressing the Exposure Compensation button until the desired compensation value is displayed.

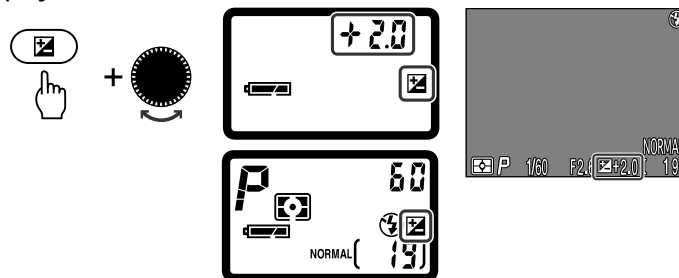

- The Exposure Compensation mark in the Control panel and Exposure Compensation mark and compensation value in the Monitor are both displayed.

### Selectable Exposure Compensation values

--2.0 ↔ --1.7 ↔ --1.3 ↔ --1.0 ↔ --0.7 ↔ --0.3  
 ↔ 0.0 ↔  
 +0.3 ↔ +0.7 ↔ +1.0 ↔ +1.3 ↔ +1.7 ↔ +2.0

### Canceling Exposure Compensation

Set the compensation value to 0.0. In mode, turn the power off.

### Check point

Exposure Compensation can also be selected from the **Exposure Options > EXP. +/-** menu (p. 110).

- Controls** In mode, the selected Exposure Compensation value can be set to remain in memory even when the power is turned off; this setting can be changed with the **Memorize** setting. (P. 130)
- Other functions can be set to be selected with the Exposure Compensation button with **FUNC. 2**. In this case, Exposure Compensation cannot be set with the Exposure Compensation button (p. 131).

Sensitivity increases the use that the camera makes of available light, allowing faster shutter speeds to be employed. However as sensitivity is increased, the picture may become noisy. Standard sensitivity is equivalent to film ISO 100. The camera will automatically increase sensitivity in low levels of ambient lighting if set to **AUTO**. The sensitivity can be increased manually from the standard value to allow faster shutter speeds in low light.

Set the Mode dial to , then rotate the Command dial while pressing the sensitivity button until the desired sensitivity value is displayed.

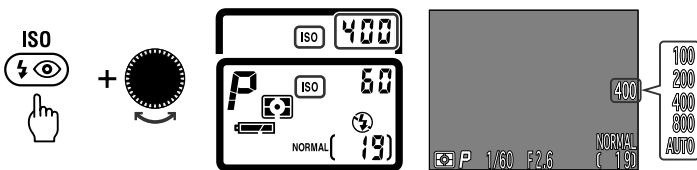



Setting	Shooting sensitivity
100	Standard sensitivity (equivalent to ISO 100) • Recommended except for shooting in dark conditions or with fast-moving subjects.
200	Equivalent to ISO 200
400	Equivalent to ISO 400
800	Equivalent to ISO 800 Note that the recorded image is rather noisy (800 is displayed in red in the Monitor).
AUTO	Set standard sensitivity under normal situations. If the brightness is low, sensitivity is automatically increased. In Shutter-Priority Auto or Manual Exposure mode, only standard sensitivity is selected • When <b>AUTO</b> is selected and sensitivity is automatically adjusted in dark conditions, the ISO sensitivity indication is displayed in the Control panel and Monitor.

### Canceling sensitivity setting

Select **AUTO** to cancel the sensitivity setting.

### Notes: Sensitivity Setting

- Manual adjustment of Sensitivity is only possible in  mode. When the Mode dial is set to  after Sensitivity is set, the setting temporarily is canceled and the camera automatically selects **AUTO** setting. If the Mode dial is set to  again, the previously adjusted Sensitivity returns.
- When the Sensitivity is set to ISO 200, 400 or 800, or Sensitivity is automatically increased in dark conditions with **AUTO**, a noisier image compared to standard Sensitivity may be recorded.
- In normal shooting situations, **400** or lower Sensitivity setting is recommended. Use the **800** setting in a situation such as when you want to avoid effects of camera shake by using a fast shutter speed. When using **800** Sensitivity, it is recommended that you turn off the **Image Sharpening** (p. 114) in Shooting Menu.

## Playback

Playback mode is used for reviewing pictures that are saved on the CF memory card, starting with the most recent first.

1 Set the Mode dial to .

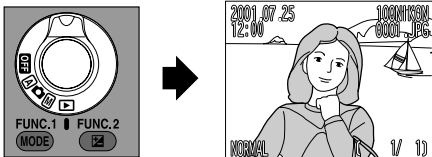

• After a short pause, the most recent photograph is displayed in full-frame with information such as the folder name, file name (number and type), date and time of recording, Image size, Image quality mode and frame number.

2 To view the previous or next photograph, press on the Multi selector.

### Playback Operation

Previous photograph	Next photograph	Selecting a photograph—Rapid Scroll
		To scroll rapidly between photographs, simply press and hold the Multi selector. The frame count will increment or decrement depending on the scroll direction. Release the Multi selector to view the selected frame.

### Check points

The message **CARD CONTAINS NO IMAGES** is displayed on the Monitor if the CF memory card contains no image file.

### Deleting photographs/setting other Playback modes

Icon	Description	Page	MONITOR Icon	Description	Page
	Deleting photographs	p. 77		Changing display on the Monitor	p. 46
	Thumbnail Playback	p. 76		Display additional photo information	p. 88
	Taking a closer look: Zooming in	p. 75			

## Taking a Closer Look: Zooming In

You can see more detail in the image by zooming into the desired area of the image.

1 Set the Mode dial to .

2 Press and hold the (Z) Zoom button to see the image in closer detail.

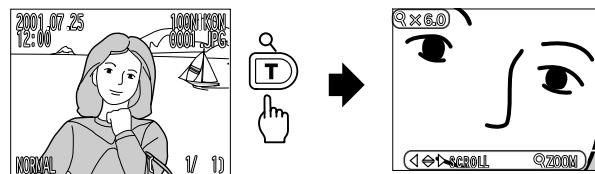

• The amount of Zoom increases each time the button is pressed, up to a maximum magnification of 6.0X. (The Zoom icon and magnification factor are displayed in the upper left corner on the Monitor.)

### Operations for Zooming

	Zooms photograph in.	Each time the  button is pressed, Zoom increases up to a maximum of 6.0X.
	Cancels Zoom.	Cancels Zoom returning the display to Full-frame playback.
	Scrolls the image.	Scrolls the image to reveal off-screen areas.

### Notes:

- Before displaying another image, cancel Zoom.
- It takes more time to zoom in an image that has been recorded with the **HI** Image quality setting.
- Images recorded in **Ultra HS** or **Movie** setting cannot be zoomed in.

## Thumbnail Playback

Up to nine Thumbnail images can be displayed on the Monitor. The Thumbnail images can be viewed a page at a time and it is possible at any time to select one Thumbnail for Full-frame playback or deleting.

1 Set the Mode dial to

2 Press the Thumbnail button once to display nine Thumbnail images, or twice to display four Thumbnail images.

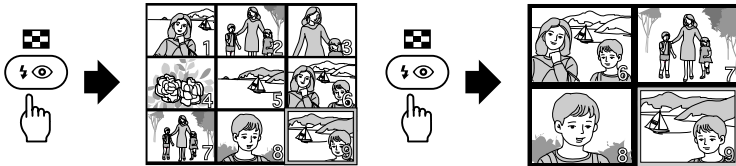

- If there are fewer than nine or four recorded images, they are displayed from the top left.
- An image that has been displayed in Full-frame playback is highlighted by a yellow frame.

### Thumbnail Playback—how it works

	Select another image.	Press the Multi selector to highlight the desired image. • Thumbnails are displayed four or nine to a page. When the last or (first) image is reached, pressing the Multi Selector flips the display to the next (or previous) page.
	Flip pages.	To flip rapidly from page to page, rotate the Command dial in the desired direction.

By pressing the Delete button in Full-frame playback or Thumbnail Playback you can delete individual images.

The Delete selection in the Playback menu enables the deletion of all or selected photographs (p. 138).

## Deleting Individual Photographs

1 Set the Mode dial to .

- The most recent photograph is displayed on the Monitor.

2 Display the photograph to be deleted using the Multi selector.

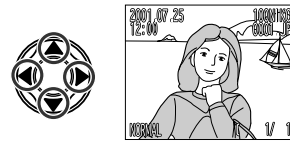

3 Press the Delete button.

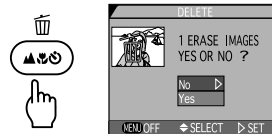

- The Delete confirmation dialog is displayed. The photograph to be deleted is shown at the upper left in the dialog display.

4 Press / on the Multi selector to highlight "Yes", then press .

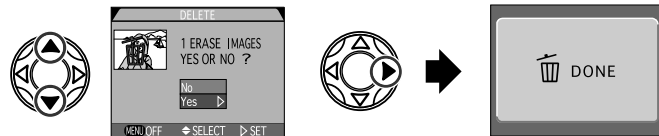

- The delete operation is confirmed with a dialog, after which the next photograph is displayed.
- To cancel delete, press on the Multi selector or select **No** by pressing /, then press to return to Full-frame playback without deleting the photograph.

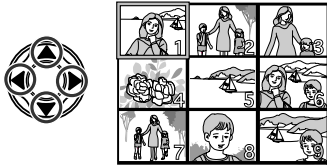

## Deleting Individual Photographs in Thumbnail Playback

- 1 Highlight the image to be deleted using the Multi selector. The selected image is marked with a yellow highlight.

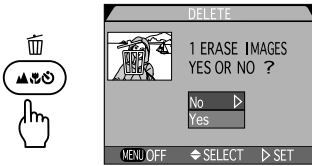

- 2 To delete the currently selected Thumbnail, press the  button.



- 3 Press / on the Multi selector to highlight "Yes", then press .

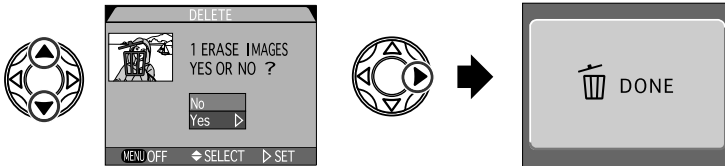

- The delete operation is confirmed with a dialog, then the Monitor returns to the Thumbnail display.

# Advanced operation

This section provides complete descriptions of advanced camera operations.



If the subject is outside of the Autofocus area, a feature called Autofocus lock can be used to maintain focus on the subject. Autofocus is locked by half pressing the shutter with the subject in the focus target area. At the same time, exposure for the main subject is memorized by the camera (Auto exposure lock). This function is convenient when the exposure should be defined by the subject.

- 1 Center the main subject between the Autofocus brackets and lightly press the Shutter release button.

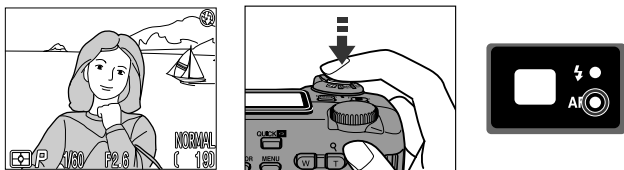

- 2 Keeping the Shutter release button lightly pressed, recompose and shoot.

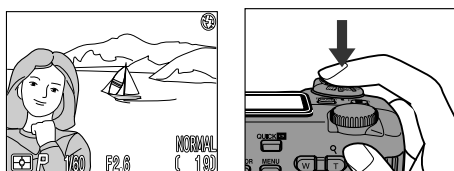

- The Green LED lights when a subject is in focus, and focus and exposure are locked.

Do not change the distance to the subject after the focus is locked.

### Check points

- The purpose of Auto exposure lock is to fix the exposure precisely on the subject. The Center-Weighted or Spot Metering modes are most suited for this purpose. For setting metering, see page 97.
- When shooting with the Autofocus lock, we recommend manually setting the focus target area (p. 111) to the center (in  mode).

When the Mode dial is set to , the camera-to-subject distance can be set manually by using Manual focus. This is convenient to ensure accurate focus when the shooting distance is known or in situations where Autofocus may not work as expected (p. 82).

To select Manual Focus rotate the Command dial while pressing the Focus mode button. **M-FOCUS** indication appears in the Control panel as confirmation. Keeping the Focus mode button pressed, rotate the Command dial again to display the shooting distance both on the Control panel and Monitor.

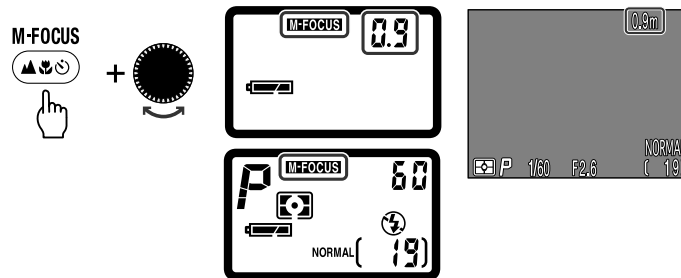

- The shooting distance can be set in 49 steps from 0.02 m (0.06 ft.) to 10 m (30 ft.), plus infinity.
- To confirm the chosen shooting distance in the Control panel, lightly press the Shutter release button.

### To Cancel Manual Focus mode

Manual Focus mode is canceled by pressing the Focus mode button. The Focus mode then returns to the last mode before Manual focus was set.

### Notes: Manual Focus

- When setting the Self-timer and the Manual Focus mode at the same time, set the Self-timer first.
- When zooming with the shooting distance set less than 0.3 m (1.0 ft.), focus is not possible in some zooming ranges. In this case, the shooting distance display in the Monitor lights in red as a warning.
- Displayed distance and the actual focus distance differ when an accessory lens converter is used.

Autofocus does not perform well under the conditions listed below. You can Autofocus as detailed below.

**1. No subject detail for Autofocus system.**

- Very dark subjects.
- Scenes with a pronounced difference in brightness (such as a subject in the shade with the sun in the background).
- Low-contrast scenes (such as a subject whose clothing is the same color as a wall or other background).



**In these instances, the following alternative focus method is suggested.**

Focus on a different subject located at the same distance and that has the same brightness but high contrast, use Autofocus lock (p. 80), then recompose and shoot.

**2. Conflicting or confusing subject detail.**

- Scenes with subjects located at different distances from the camera.
- Fast-moving subjects



**In these instances, the following alternative focus method is suggested.**

Focus on a different subject located at the same distance and that has the same brightness, use Autofocus lock (p. 80), then recompose and shoot.

**Note: Focus lock**

When you lock focus, make sure to mentally check the exposure as Auto exposure is locked at the same time.

A Movie can be recorded for a maximum of approx. 40 seconds. Each frame has NORMAL Image quality and is of QVGA Image size (320 x 240 pixels). The recorded Movie image can be played back on the Monitor.

**Movie Shooting Mode**

- 1 Select "Continuous" > "Movie" (p. 99) in the Shooting menu in  mode.

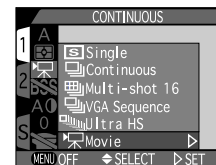
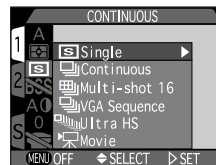

- 2 Fully depress the Shutter release button to start recording your movie.

- 3 Fully depress the Shutter release button again to stop recording.

- If you forget to fully depress the Shutter release button to end the movie, the camera will automatically stop the operation after 40 seconds.
- The camera records movies at 15 frames per second in QVGA size (320 x 240 pixels). The file is recorded in QuickTime format (DOS file extension ".MOV").

**Movie Playback Mode**

Press  button to play back the movie.

- After completing the playback, the final frame is displayed for one second, and then returns to the still image of the first frame.

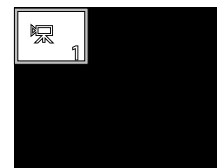
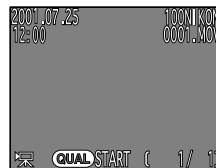

## Operation in Movie Playback mode





When the first frame is displayed as a still image

	Start movie	After completing the playback, the final frame is displayed for one second, and then returns to the still image of the first frame.
--	-------------	---

While movie is in progress



	Pause movie	The movie stops and a still image of the frame when the button was pressed is displayed.
--	-------------	--

While the movie is paused (still image display except the first frame)



	Resume movie	Resume Movie Playback from the displayed still image
	Display previous frame	Display the previous frame of the movie
	(While a frame in the middle is displayed) Display next frame	Display the next frame of the movie
	(While the last frame is displayed) End movie Playback	The first frame is displayed after ending movie Playback

When taking photographs with the Monitor on, it is possible to immediately cancel the image being recorded and to extend the display of a wanted image after the shutter is released.

## Quick Delete

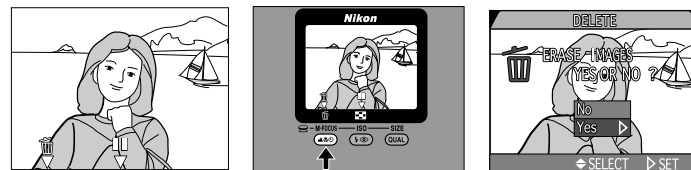
Press the delete button  while an image is being recorded and  is displayed on the Monitor.



- When the delete button is pressed, the confirmation dialog appears. Select **Yes** by pressing the / on the Multi selector and press  to cancel recording of the image data to the CF memory card.



## Check point



When **Disable delete** in the Shooting SET-UP menu is **On**, the  is not displayed when the delete button is pressed. The dialog **CANNOT DELETE FILE** appears in the Monitor and the image cannot be deleted (p. 135).

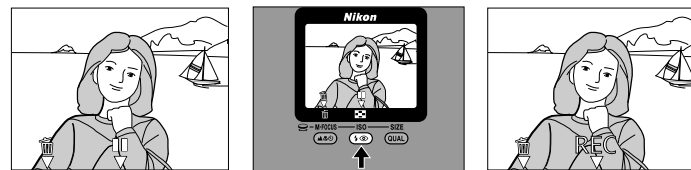

## Holding the Image on the Display

Press the Flash Mode button  while an image is being recorded and  is displayed on the Monitor.





- The **REC** mark is displayed on the Monitor and the image is held for 20 seconds after which the image is saved to the memory card and the display returns to the normal shooting display.
- The displayed image can also be saved as any time by pressing the Flash mode button  while the **REC** indication is displayed. To cancel, press the delete button . The delete confirmation dialog appears, from which it is possible to delete the image.

Quick review mode/Full-screen review mode is set by pressing the QUICK review button  in Shooting mode Shooting Mode .



These two review modes enable you to quickly review and confirm the image without having to turn the Mode dial from Shooting Mode  to Review Mode .

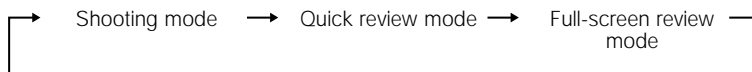

- The display in the Monitor changes as follows each time the QUICK  button is pressed when the Mode dial is set to Shooting mode Shooting Mode .



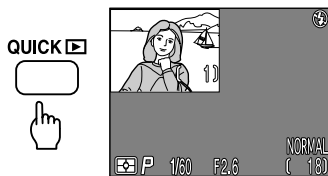

## Quick Review Mode

Press the QUICK  button in a Shooting mode Shooting Mode  to set the camera to Quick review mode.



- In Quick review mode, a small image of the most recent shot is displayed in the top left corner of the Monitor. Pressing the Multi selector scrolls through the saved images on the CF memory card. It is possible to take further photos at any time.
- When there are no recorded images available, the Monitor displays the message **CARD CONTAINS NO IMAGES** and returns to the Shooting mode display.

## Various operations in Quick review mode

- In Quick review mode, the Focus mode button , Flash mode button  (when the built-in Speedlight is raised), Exposure Compensation button  and Zoom buttons remain active.
- Previously set Shooting mode conditions (Exposure value, Autofocus, White balance [Auto]) are memorized in Quick review mode.

## Completing the Quick review mode

- The following operations end the Quick review mode and return the camera to Shooting mode.
  - Lightly pressing the Shutter release button
  - Setting the Mode dial to another position
  - When the camera's power is turned off automatically by the Auto Power-off function

## Full-Screen Review Mode

Press the QUICK  button in the Quick review mode to set the camera to Full-Screen Review mode.

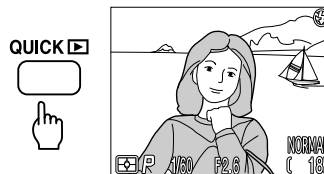

- When the QUICK button  is pressed in the Quick review mode, the small image is enlarged and displayed full-screen. This sets the camera in a temporary Playback mode so that the normal playback functions of Zoom, Delete and Thumbnail playback are possible.

## Completing the Full-screen review mode

- The following operations end the Full-screen review mode and return the camera to Shooting mode.
  - Pressing the QUICK button 
  - Lightly pressing the Shutter release button
  - Setting the Mode dial to another position
  - When the camera's power is turned off automatically by the Auto Power-off function

# Viewing Additional Picture Information

Rotating the Command dial changes the display to the following five screens while a picture is displayed on the Monitor in any Full-frame playback mode.

1. Basic display
2. Detailed information display 1
3. Detailed information display 2
4. Histogram display
5. Focus confirmation display

• The contents of the image information displayed are as follows.

## 1. Basic display screen

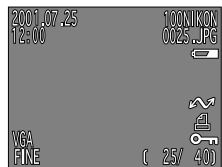

Display	Description
100 Nikon	Folder name
0025.JPG	File number (the last 4 numbers and file type)
	Battery indication (displayed only when battery power is insufficient)
	Auto transfer icon (displayed on the image in the Auto transfer setting)
	Print-order selection icon (displayed on the print-ordered image)
	Protect icon (displayed on the protected image)
25/40	Frame number/total number of frames visible in current folder
2001. 07. 25	Date when the picture was taken
12:00	Time when the picture was taken
VGA	Image size (UXGA, SXGA, XGA, VGA, 3:2, QVGA)
FINE	Image quality (HI, FINE, NORMAL, BASIC)

## 2. Detailed information display 1



Display	Description
CAMERA : E995	Camera type
FIRM VER : E995 V1.0	Firmware version (displayed only on images shot with COOLPIX995)
METERING : MATRIX	Metering system
MODE : P	Exposure mode
SHUTTER : 1/60	Shutter speed
APERTURE : f2.6	Aperture
EXP +/- : 0.0	Exposure Compensation
FOCAL LENGTH : f8.2mm	Focal length
FOCUS : AF	Focus mode (distance setting information when in Manual focus)

## 3. Detailed information display 2



Display	Description
SPEEDLIGHT : ON	Flash status
IMG ADJUST : AUTO	Image adjustment
SENSITIVITY : AUTO	Sensitivity (ISO equivalency)
WHITEBAL : AUTO	White balance
SATURATION : +1	Saturation control
SHARPNESS : AUTO	Image sharpening
DIGITAL TELE : X1.00	Digital zoom ratio
CONVERTER : OFF	Lens converter status
FILE SIZE : 713KB	File size (kilobytes)

## 4. Histogram display

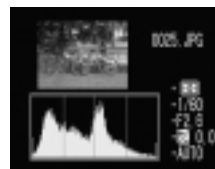

Display	Description
Thumbnail image	Highlighted part of image flashes in black/white to show over-exposed areas
Histogram	Show histogram of displayed image
Shooting information	Shooting information of displayed image (file number and type, metering system, shutter speed, aperture, Exposure Compensation, sensitivity)

• The Histogram display shows the distribution of tones in the image: the horizontal axis ranges from black (left) to white (right), while the vertical axis shows the number of pixels of each brightness in the image. A properly exposed image will extend close to the ends of the histogram and should not have a large value at the extremes of the tone range.

## 5. Focus confirmation display



Display	Description
Focus confirmation image	Portions of image in focus are sharply outlined
Shooting information	Shooting information of displayed image (file number and type, focal length, shutter speed, aperture, Focus mode [distance setting information in Manual focus], selected AF area, Noise Reduction)

# Sync Terminal

External Nikon Speedlights can be accommodated by using the optional Multi-Flash Bracket Unit SK-E900.

- 1 Remove the Sync terminal cover and connect the camera plug of the multiple flash adapter.

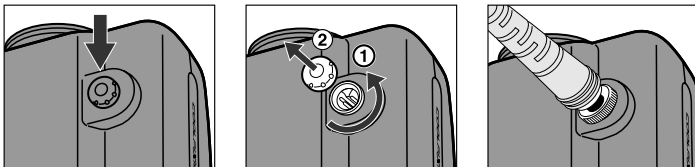

- The following Nikon optional Speedlights can be used: SB-28DX, SB-28, SB-26, SB-25, SB-24, SB-22s and SB-22. Please contact an authorized Nikon dealer or service center about using other Nikon Speedlights.
- In Macro close-up mode, it is recommend that you take trial shots and confirm that the image in the Monitor is correctly exposed.
- Set the Zoom-head position wider than 28mm.  
The Power Zoom function of Speedlights does not function when attached to the COOLPIX995. Please set the Zoom-head position manually.
- The AF assist illuminator of the Speedlight does not illuminate.
- For the basic functions and operations of Multi-Flash Bracket Unit SK-E900 and optional Speedlights, please refer to the instruction manuals supplied with each accessory.

### Check point

With the **Speedlight Opt.** > **Int Flash Off** in Shooting SET-UP menu , it is possible to set the built-in Speedlight so that it does not fire, and to fire the external Speedlight only (p.133).

### Note: Flash Units Made by Manufacturers other than Nikon

Use only Nikon Speedlights. Other units may damage the camera's electrical circuitry due to incompatible voltage requirements, electric contact alignment or switching phase.







### Note: Activating an Optional Speedlight

When using an optional Speedlight, make sure to raise the built-in Speedlight to operational position (even if the **Int Flash Off** setting is set on the built-in Speedlight) to ensure that the flash sync sensor is activated.

# Using the Camera Menu

This section describes the menu used to manage the more advanced features available on the COOLPIX995.

Separate menus are available for each mode:

Menu	Function	Mode	Page
Shooting	Advanced Shooting options (e.g., White Balance, Metering, Continuous)		92-119
SET-UP	Basic camera setup (e.g., formatting CF memory cards, setting date/time). SET-UP menus for the  and  modes are accessible from the Shooting and Playback menus respectively. The options available depend on the operation mode		120-129
			120-135
			148-152
Playback	Playback options		136-147

The Menu share a common operation method, making it easy for you to learn and remember how to navigate around the menus and make selections quickly and confidently.

# Setting Shooting Menus

Shooting Mode

In Shooting mode, the Shooting menu provides access to a range of camera setting adjustments, such as the White balance, Saturation control and Noise reduction.

The Shooting menu contains two pages of advanced shooting options:

## SHOOTING MENU 1

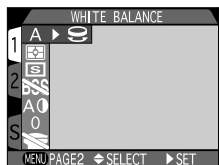

A	WHITE BALANCE		P. 95
	METERING		P. 97
S	CONTINUOUS		P. 99
	BEST SHOT SELECTOR		P. 102
A	IMAGE ADJUSTMENT		P. 104
O	SATURATION CONTROL		P. 105
	LENS		P. 106

## SHOOTING MENU 2

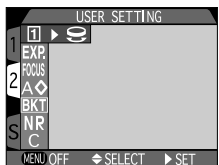

T	USER SETTING		P. 108
EXP.	EXPOSURE OPTIONS		P. 109
FOCUS	FOCUS OPTIONS		P. 111
A	IMAGE SHARPENING		P. 114
BKT	AUTO BRACKETING		P. 115
NR	NOISE REDUCTION		P. 117
C	RESET ALL		P. 118

## Displaying the Shooting Menu

Set the Mode dial to and press the MENU button to display the Shooting menu on the Monitor.

- The desired menu item can be selected with the Multi selector.

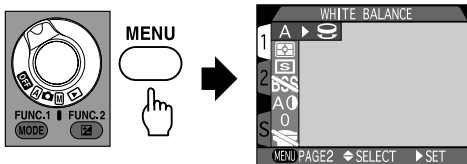

- To go back one step, press on the Multi selector.
- Changes to settings apply as soon as the selection is made.

### Check point

In the and Shooting modes, pressing the Shutter button will cause the camera to quit the MENU and return to Shooting mode for as long as the shutter is lightly pressed.

## Choosing from the Shooting Menu (example: Focus Mode)

### 1 Select the Shooting menu item.

- Press on the Multi selector to highlight the desired menu item, then press to display the options for the selected item.

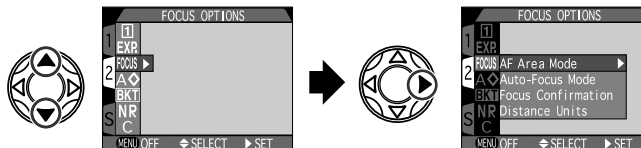

### 2 Select the option for the selected item.

- Press to highlight the desired option, then press to display further options for the selected option.

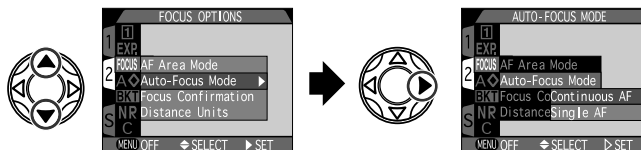

### 3 Set the option.

- Press to highlight the option, then press to confirm. The Monitor then returns to the Shooting menu.

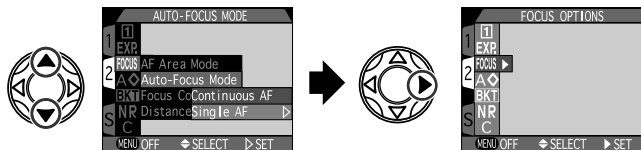

### 4 Complete the setting by pressing the MENU button.

- The Monitor then returns to Shooting mode.

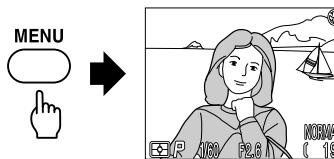

### Check points: Moving from page to page

- In the Shooting mode, two menu pages follow each other so that when you reach the end of page 1, page 2 then appears. The number tab for the active page is highlighted in white. To move to the SET-UP page, press ◀ on the Multi selector to turn the white tab orange. Then press ▲/▼ on the Multi selector to move between pages 1, 2 and Set Up. Select the S tab with ▲/▼ to display SET-UP 1 and press ▶.
- In the Shooting mode, if MENU PAGE 2 is displayed in the lower left corner of the menu screen, pressing the MENU button will display the second page of the menu. Pressing the MENU button when MENU OFF is displayed clears the menu from the Monitor.

### Using the Command Dial to Make a Selection

If the symbol (Command dial) appears to the right of a menu item, you can select an option quickly by rotating the Command dial instead of using the Multi selector.

#### 1 Select the menu item with the Multi selector.

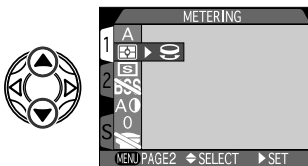

#### 2 Rotate the Command dial to display the icon for the desired option.

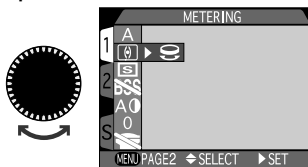

- Complete the setting by pressing the MENU button twice in **SHOOTING MENU 1** or once in **SHOOTING MENU 2**.

### WHITE BALANCE

Human vision compensates for variations in the color of normal ambient lighting so that we see white and gray objects as neutral. Film cameras cannot compensate for such changes in lighting (called the color temperature) except by the choice of film, or in some cases by using filters. Digital cameras attempt to mimic humans by measuring the color temperature and compensating automatically. This is known as **White Balance**. The **White Balance** may be preset to one of a number of fixed values and can also be measured manually.

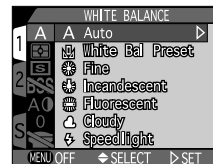

A Auto	White balance is measured and adjusted automatically.
White Bal Preset	White balance is measured and adjusted using the color temperature measurement for a sample placed in the same lighting as the subject.
Fine  *1	Preset for bright daylight
Incandescent  *1	Preset for incandescent (tungsten) light
Fluorescent  *2	Preset for fluorescent light
Cloudy  *1	Preset for cloudy or overcast skies
Speedlight  *1	Preset for flash photography

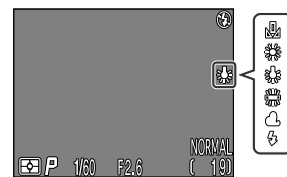

- The **White Balance** icon is displayed on the Monitor when a **White Balance** setting other than **Auto** is selected.

\*1 You can make additional fine adjustments to the **White Balance** through a range of -3 to +3 (in single steps) by rotating the Command dial. A negative adjustment tends to make the image reddish while a positive adjustment tends to make the image bluish. Press ▶ on the Multi selector to set the adjustment.

\*2 You can select **FL1**, **FL2** or **FL3** for different types of fluorescent light, such as warm daylight, neutral etc., by rotating the Command dial.

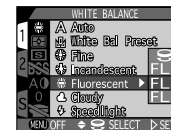
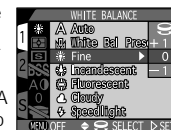

Selection	Light source
FL1	White (W)
FL2	Daylight white (Neutral, N)
FL3	Daylight (D)



## — Preset White Balance —

In certain lighting, you may find that you can obtain a more accurate color balance by measuring the color temperature of the light manually. The **Preset White Balance** function allows you to photograph a neutral object (usually a piece of gray card) from which the camera calculates the color temperature. The camera then automatically recalibrates the white balance according to the result.



- When **White Bal Preset** is selected, the camera will Zoom in and the preset white-balance menu will appear on the Monitor.

### Cancel

Select **Cancel** to abort the **Preset White Balance** setting, and then press the **▶** on the Multi selector to return the white balance to its most recent setting. The lens also returns to its previous position.

### Measure

To measure the color temperature, select **Measure** and then place a flat neutral object such as a piece of gray card in the same lighting as the intended subject. Then press **▶** on the Multi selector to take a sample image. The camera measures the color temperature and the recalibrates the white balance.

#### Note:

When you select **Measure**, the camera will beep and zoom out, but no photograph will be taken.

## METERING

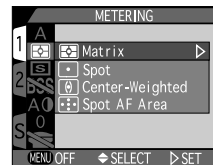

The **METERING** menu offers a choice of four metering methods. Choose the best metering method for your composition and lighting conditions.



<b>Matrix</b>	Good for most situations.
<b>Spot</b>	Best when you want to set the exposure based on a small area of the picture, (e.g. a subject surrounded by a dark background).
<b>Center-Weighted</b>	A useful compromise between Spot and Matrix. Useful when the lighting on the subject is to be used to define the exposure, but extends over a larger area.
<b>Spot AF Area</b>	Set Spot AF Area Metering when you want the exposure measurement to be defined by the selected AF area target.

Metering system	Characteristic	Shooting situations
<b>Matrix</b>	Determines the exposure measurement by dividing up the image into 256 separate elements and creating an appropriate exposure calculation according to the particular balance of subject and background.	Recommended for use in most situations.
<b>Spot</b>	The camera measures light in an area in the center of the frame occupying roughly 1/32 of the total Monitor area, indicated by the square in center of the Monitor.	Best used when the subject is backlit or there is a pronounced contrast in the frame such that exposure should be based on a just a small area of the frame.
<b>Center-Weighted</b>	Exposure is calculated based on the central 1/4 of the entire frame contributing 80 percent of the exposure calculation. When you use the Digital zoom, Center-Weighted Metering is automatically selected.	Useful when you want to base the exposure measurement on the center of the frame.

\* Metering method is automatically set to Center-Weighted when Digital zoom is activated.

Metering system	Characteristic	Shooting situations
 Spot AF Area	<p>Spot AF Area Metering can be selected when the autofocus mode in <b>FOCUS OPTIONS &gt; AF Area Mode</b> (p. 111) in Shooting Mode  is set to <b>Auto</b> or <b>Manual</b>.</p> <p><b>Auto:</b> Automatically shifts the Spot Metering area to one of five focus areas.</p> <p><b>Manual:</b> Spot Metering area is shifted to one of five focus areas in the AF Area selected.</p> <p><b>Off:</b> Matrix Metering is automatically selected.</p> <p>When the Monitor is off, the metering area does not shift to the AF target area and remains fixed in the center AF Area.</p>	Useful when you want to base the exposure on a small area within the frame without changing the composition since the metering area shifts with the AF Area.

- When you set the Metering mode, the Metering indications are displayed on the Control panel and on the Monitor.

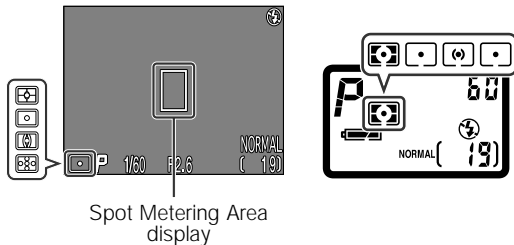







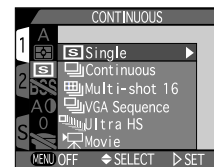





Spot Metering Area display

## CONTINUOUS

The COOLPIX995 is capable of taking shots singly or in a continuous sequence at a number of different frame rates and resolutions.



 Single	Records a single picture when you press the Shutter release button.
 Continuous	Records images continuously at the highest possible speed.
 Multi-shot 16	Records 16 small images as a collage in one image size.
 VGA Sequence	Records images at low resolution at 2 fps.
 Ultra HS	Records 70 frames at 30 fps.
 Movie	Records a movie file.

Options	Description	Selectable Image Size (pixel)	Selectable Image Quality mode	Shooting speed (in NORMAL)
 Single	Records a single frame each time you press the Shutter release button fully.	All Image Size	All Image quality mode	—
 Continuous	Record image continuously for as long as the Shutter release button is kept fully depressed until the memory buffer becomes full.	All Image Size	Other than HI	Approx. 1.5fps* in FULL
 Multi-shot 16	When you press the Shutter release button fully, 16 consecutive images are recorded and combined into a single image collage.	FULL (2048 x 1536)	Other than HI	—
 VGA Sequence	Records images continuously at high-speed for as long as the Shutter release button is kept fully depressed. Because the images are small compared to the buffer capacity, you can continue to record image until the CF memory card is full.	VGA (640 x 480)	NORMAL	Approx. 2fps*
 Ultra HS	When you press the Shutter release button fully, 70 images are recorded at approx. 30fps. The images are stored in a unique new folder designated "N_" created every time an <b>Ultra HS</b> sequence is recorded. All 70 images are saved in this folder.	QVGA (320 x 240)	NORMAL	Approx. 30fps
 Movie	Records a movie up to approx. 40 sec. in length when you press the Shutter release button fully. To interrupt movie recording, press the Shutter release button fully again.	QVGA (320 x 240)	NORMAL	Approx. 15fps

- \* The shooting speed varies with the memory available in the camera.
- Once shooting has commenced, the Autofocus mode, exposure value and white balance settings in the **Continuous**, **Multi-shot 16**, **VGA Sequence** and **Ultra HS** modes are fixed at their initial values

### Note: CF memory card

After shooting a sequence, do not remove the CF memory card from the camera until all the pictures have been saved. In **Ultra HS** or **Movie** mode, images are first recorded in the camera's buffer memory and then saved on the CF memory card, which takes longer. The  indication is displayed while the camera is saving images to the CF Memory.

- The Continuous menu settings (other than Single) are indicated by an icon on the Control panel and on the Monitor.

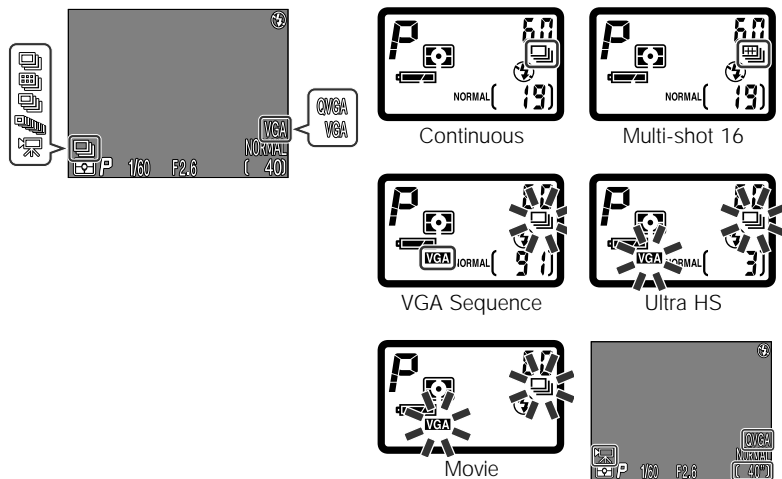

### Check point

The progress of continuous shooting is indicated on the Monitor in **Ultra HS** mode. Shooting can be interrupted by releasing your finger from the shutter release button.



### Ultra HS and Movie mode

- To playback images recorded in **Ultra HS** mode, set the **Folders** setting to **All Folders** or to one of the folders that starts with "N\_" in which **Ultra HS** sequences are stored. Note that when you set the camera (from the **Reset All** menu), the **Folders** setting is reset to **All Folders**.
- When you take a self portrait with the camera lens swiveled to point backwards, the image displayed on the Monitor during shooting and the image displayed during playback both appear upside down.
- To use **Ultra HS** or **Movie** mode, the Monitor must be turned on. Single frame shooting is automatically selected when the Monitor is off.
- The **Best Shot Selector**, **Auto Bracketing** and **Focus Confirmation** functions are set to off in **Movie** mode.
- The **Best Shot Selector**, **Auto Bracketing** functions are set to off in **Ultra HS** mode.

### Notes: Speedlight



- When a **Continuous** mode (other than **Single**) is selected, the built-in Speedlight does not fire even when the Speedlight is raised. It is recommended that you close the Speedlight since underexposure may occur.
- Multiple flash (operation with more than one Speedlight) (p. 90) can be used in **Single**, **Continuous**, **Multi-shot 16** and **VGA Sequence** modes (with the optional multiple flash bracket SK-E900 [p. 162], etc.). In multiple flash shooting, be sure to set the built-in Speedlight to the up position since the flash sync sensor does not operate when the built-in Speedlight is stowed.

### BEST SHOT SELECTOR

The **Best Shot Selector** function is most effective in situations where inadvertent camera movement may affect the outcome of the photograph, such as the following:



- The camera is zoomed in or you are using an optional teleconverter lens attachment.
- you are using Macro Close-up
- the subject is dark and the shutter speed is slow

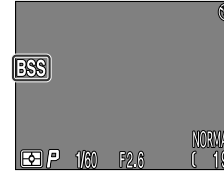

 Off	Best Shot Selector off
 On	Best Shot Selector on



When the **Best Shot Selector** is **On**, the **Best Shot Selector** indication is displayed on the Monitor.

 Off	Best Shot Selector is off and the regular Shooting mode is used.
 On	Holding down the Shutter release button fully records up to 10 images continuously. The recorded images are stored in the camera's buffer memory and the most sharply focused image is automatically selected after the sequence is complete. The selected image is then stored on the CF memory card. Autofocus, exposure and white balance settings are determined by the settings for the first frame.

#### Notes: Best Shot Selector

- The **Best Shot Selector** cannot be set to **On** in the following situations:  
When **Continuous** mode is set to **Continuous, Multi-shot 16, VGA Sequence, Ultra HS** or **Movie** (p. 99).  
When the Image Quality mode is set to **HI** (p. 58).
- Even when raised, the built-in Speedlight does not fire when the **Best Shot Selector** is on.
- The **Best Shot Selector** function may not be effective in recording the most sharply focused image when it is used to shoot a fast-moving subject or if the composition is changed during continuous shooting.

### IMAGE ADJUSTMENT

When you take a photograph, the camera automatically compensates for optical brightness and contrast before recording the photograph on the CF memory card. The **Image Adjustment** menu gives you control over this image compensation.



<input checked="" type="radio"/> <b>Auto</b>	Image is adjusted automatically.
<input type="radio"/> <b>Normal</b>	Image adjustment is fixed at standard level
<input checked="" type="radio"/> <b>+ More Contrast</b>	Increases the image contrast
<input checked="" type="radio"/> <b>- Less Contrast</b>	Decreases the image contrast
<input checked="" type="radio"/> <b>+ Lighten Image</b>	Increases the image brightness
<input checked="" type="radio"/> <b>- Darken Image</b>	Decreases the image brightness

Option	Description
<input checked="" type="radio"/> <b>Auto</b>	The camera automatically adjusts the contrast and brightness of the image according to shooting conditions.
<input type="radio"/> <b>Normal</b>	The camera performs same standard brightness and contrast adjustment for all images. This setting is recommended for images that will later be retouched on a computer.
<input checked="" type="radio"/> <b>+ More Contrast</b>	The image is processed to emphasize the difference between light and dark areas. This is useful when shooting landscapes and foggy or cloudy scenes.
<input checked="" type="radio"/> <b>- Less Contrast</b>	The image is processed to reduce the difference between light and dark areas. This is useful in conditions where the light is very bright with strong shadows cast on the subject.
<input checked="" type="radio"/> <b>+ Lighten Image</b>	Increases the brightness of mid-tones in the image without affecting detail in the highlights and shadows. This setting can be used on images that appear too dark when displayed or printed.
<input checked="" type="radio"/> <b>- Darken Image</b>	Decreases the brightness of mid-tones in the image without affecting detail in the highlights or shadows. This setting can be used on images that appear too bright when displayed or printed.



- The **Image Adjustment** indication is displayed on the Monitor when an **Image Adjustment** other than **Auto** or **Normal** is set.

### SATURATION CONTROL

Adjust the **Saturation** to control the intensity of color in the picture. In this mode, you can specify a **B&W** (black-and-white) image.

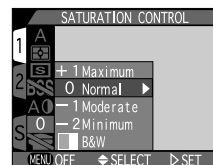

<input checked="" type="radio"/> <b>+1 Maximum</b>	Sets the saturation level to +1.
<input type="radio"/> <b>0 Normal</b>	Sets the saturation level to normal.
<input type="radio"/> <b>-1 Moderate</b>	Sets the saturation level to -1.
<input type="radio"/> <b>-2 Minimum</b>	Sets the saturation level to -2.
<input checked="" type="radio"/> <b>B&amp;W</b>	Sets image to black-and-white.

Option	Description
<input checked="" type="radio"/> <b>+1 Maximum</b>	Increases the color saturation of the image. Suitable for direct printing where a photo-print effect is required.
<input type="radio"/> <b>0 Normal</b> <input type="radio"/> <b>-1 Moderate</b> <input type="radio"/> <b>-2 Minimum</b>	Sets the saturation control level to normal. Saturation can be decreased to normal to -1 (moderate) or -2 (minimum). Suitable for images intended for subsequent retouching or manipulation on a computer.
<input checked="" type="radio"/> <b>B&amp;W</b>	Images are recorded as monochrome data and the display on the Monitor also changes to black-and-white. The size of the image file is the same as for the color image but the resolution is higher.



- The **B&W** (black-and-white) indication is displayed on the Monitor when **B&W** is selected.

### LENS



Optional lens converters for wideangle, telephoto and fisheye photography can be used with the COOLPIX995. A Slide Copy Adapter is also available. Each of these converter is adapted to a particular combination of settings, such as the Focus mode, Zoom position and Metering method.



	<b>Normal</b>	Normal setting
	<b>Wide Adapter</b>	Wideangle Converter setting
	<b>Telephoto 1</b>	2x Telephoto Converter TC-E2 setting
	<b>Telephoto 2</b>	3x Telephoto Converter TC-E3ED setting
	<b>Fisheye 1</b>	Fisheye Converter setting (Records a circular image.)
	<b>Fisheye 2</b>	Fisheye Converter setting (The corners of the rectangular image are included in image.)
	<b>Slide Copy Adptr</b>	Slide Copy Adapter setting

Option	Button locked	Focal length	Zooming
<b>Wide Adapter</b>	*1	Widest angle	Enabled after setting
<b>Telephoto 1</b>	*1	Maximum telephoto	Enabled after setting
<b>Telephoto 2</b>	*1	Maximum telephoto	Enabled after setting
<b>Fisheye 1</b> <sup>2</sup>	*3  *4	Widest angle	Disabled
<b>Fisheye 2</b>	*3  *4	Middle	Disabled
<b>Slide Copy Adptr</b> <sup>5</sup>	*3  *4	Macro	Enabled after setting

\*1 The built-in Speedlight is set to Flash Cancel. Only an optional external Speedlight can be fired.  
 \*2 The Focal length is fixed to infinity, the metering system to Center-Weighted and the range of selectable apertures is limited.  
 \*3 The Self-timer can be set.  
 \*4 Both the built-in Speedlight and any optional external Speedlight are set to **Flash Cancel**.  
 \*5 Less contrast is set for **Image Adjustment** and compensation of +0.7 EV is set. This can be changed after the setting is made.

### Swivel Lock

The Swivel Lock function, prevents the lens section of the camera from being unintentionally swiveled beyond the horizontal position by the weight of an optional lens converter.

Slide the Swivel Lock lever in the direction of the arrow to activate the Swivel Lock function and lock the lens section of the camera so that it cannot be rotated more than 90° forward (vertical position).

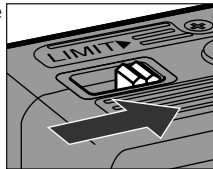

### — Slide Copy Adapter —

Select **Slide Copy Adptr** when the camera is attached to a Slide Copy Adapter to copy a 35mm type color slide film or check the images on negative film.

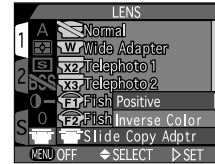

<b>Positive</b>	Setting for color slide film
<b>Inverse Color</b>	Setting for negative film

### Inverse color mode

- Bright lighting is required in **Inverse Color** mode when checking negative film on a Slide Copy Adapter. If the lighting is insufficient, the image on the Monitor appears too bright. If the image is affected by noise (interference), set the **Image Sharpening** to **Off** or **Low** (p. 114).
- Inverse Color** mode is only intended for checking negative film, and image quality varies significantly depending on the type or manufacturer of the film being used. To obtain high-quality images, use of a film scanner such as the Nikon COOLSCAN is recommended.

### Notes: Lens setting

- The built-in Speedlight does not fire when the **Lens** settings is set to **Fisheye 1**, **Fisheye 2** or **Slide Copy Adptr**. The Flash Cancel indication is displayed on the Control panel and Monitor.
- Refer to the instruction manual for the optional lens converter or Slide Copy Adapter for details.

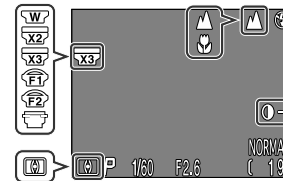

- The **Lens** setting indication is displayed on the Monitor when a **Lens** setting other than **Normal** is selected.
- When **Fisheye 1** is selected, the Infinity and Center-Weighted Metering indications are also displayed on the Monitor.
- When **Slide Copy Adptr** is selected, the **Macro** and **Less Contrast** indications are also displayed on the Monitor.

## USER SETTING

The camera can “memorize” up to three combinations of settings, including White Balance, Metering, Continuous, Best Shot Selector, Image Adjustment, Saturation Control, Lens and Image Sharpening. These settings can be recalled as desired, allowing you to create separate combinations of settings for different shooting conditions and then recall them later at a touch.

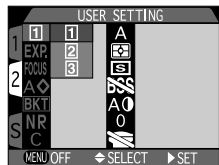

<b>1</b>	User Setting 1	Desired combination of menu settings can be stored in memory.
<b>2</b>	User Setting 2	
<b>3</b>	User Setting 3	

### 1 Select User Setting. The User Setting number and the icons for the menu items are displayed.

- By default, any changes made to settings are automatically saved as User Setting 1.
- Settings that have not been changed from the default values are shown in white. Settings that differ from the defaults are shown in orange.

### 2 To store the desired settings in User Setting 2 or 3, highlight 2 or 3 by pressing / on the Multi selector and then press / to select. Then, set the desired menu item from the Shooting menu.

- The icon for the selected menu item is displayed in orange.
- When menu item option is changed in each User Setting number, the new setting is stored in memory.

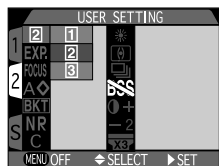

- The User Setting number is displayed in the upper left corner of the Monitor when User Setting 2 or 3 is selected.

## EXPOSURE OPTIONS

In certain cases, you may want to modify the exposure setting as metered by the camera so as to intentionally over- or underexpose the image. This is known as exposure compensation. Alternatively, you may wish to maintain the same exposure over a number of different images, for example when you are taking pictures that must be composited or displayed together.

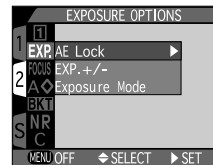

<b>AE Lock</b>	Setting Exposure Lock
<b>EXP. +/-</b>	Setting Exposure Compensation
<b>Exposure mode</b>	Setting Exposure mode

### — AE Lock —

Use the AE Lock to record a number of shots with the same aperture, shutter speed, sensitivity and white balance settings. This is useful in situations such as when you want to join or retouch images on a computer.





- **AE-L** (Auto Exposure Lock) and **WB-L** (White Balance Lock) are displayed on the Monitor when **AE Lock** is set. If you choose **Reset**, these icons will turn yellow to indicate that exposure will be reset with the next shot.

<b>Off</b>	Exposure Lock is canceled and normal exposure control is resumed.
<b>On</b>	Exposure control (aperture, shutter speed, sensitivity and white balance) are locked to the settings for the first image recorded after <b>On</b> setting. <ul style="list-style-type: none"> <li>• The flash is canceled. Do not release the built-in Speedlight.</li> </ul>
<b>Reset</b>	Locked exposure control is reset and the exposure control (the aperture, shutter speed, sensitivity and white balance settings) will be locked to the settings for the first image recorded after resetting.

### — Exposure Compensation —

Exposure metering can be offset to allow manual compensation for more creative control of your pictures. Twelve settings are available for Exposure Compensation, from -2EV to +2EV in 1/3-EV steps.



- The Exposure Compensation indication  is displayed on the Control panel and both  and the compensation value are shown on the Monitor when the Exposure Compensation is set.

#### Check point

The flash output level is also adjusted when the Speedlight is used. To adjust only the flash output level and leave the exposure metering as determined by the camera, select **Speedlight Opt. > Variable Power** in the Shooting SET-UP menu (p. 133).

### — Exposure mode —

The Exposure mode can be selected by pressing the Multi selector instead of using the MODE button and the Command dial. This option cannot be selected if MODE is assigned to either the FUNC. 1 or FUNC. 2 button in the Controls setting (p. 130) in the Shooting SET-UP menu. See p. 65 for the characteristics of the Exposure modes and details on using them.

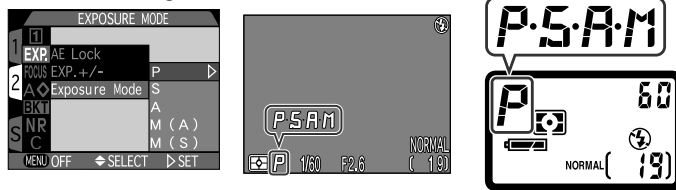

#### Check point

Set the shutter speed in the **S** exposure mode or the aperture in the **A** exposure mode by rotating the Command dial as described in “Setting the Exposure mode” on p. 64. However, in **M** exposure mode, set **M (A)** to select the aperture and **M (S)** to select the shutter speed by rotating the Command dial.

### FOCUS OPTIONS

You can use the Focus Options menu to select the AF Area Mode, change the Auto-Focus Mode, select Focus Confirmation or change the Distance Units.

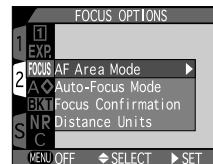

<b>AF Area Mode</b>	Setting AF Area mode selection
<b>Auto-Focus Mode</b>	Sets the autofocus mode
<b>Focus Confirmation</b>	Sets the focus confirmation selection
<b>Distance Units</b>	Sets the units used for distance display



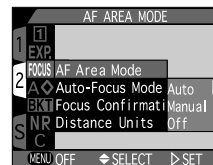

### — AF Area Mode —

Focus using the five AF Areas on the Monitor.

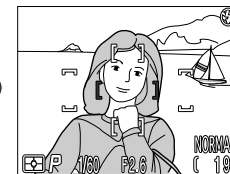

- When **Manual** is selected in **AF Area Mode**, press the Multi selector up, down, left or right to select the AF Area.



<b>Auto</b>	All five AF Areas are used to focus the image. The camera will automatically select the AF Area for the subject closest to the camera. This function minimizes the chance of out-of-focus pictures. The automatically selected AF Area is identified by the indicator that glows red on the Monitor when the Shutter release button is pressed lightly.
<b>Manual</b>	Focusing is targeted on one of five AF Areas selected on the Monitor. Press  /  /  /  on the Multi selector to select the desired AF Area. The selected AF Area is indicated in red on the Monitor. This is useful in situations where the aim is to focus precisely on a single AF Area with a relatively stable subject.
<b>Off</b>	Only the center AF Area is used for focusing. This is useful in Autofocus Lock/Auto Exposure Lock operation (p. 80).

#### Note: AF Area selection

**Auto** and **Manual** settings can only be selected when the Monitor is turned on. **AF Area Mode** is automatically set to **Off** when the Monitor is off or the Digital zoom is activated.



### — Auto-Focus Mode —

The camera Auto-Focus can operate in two modes: Continuous AF and Single AF.

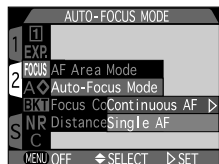

Continuous AF	As long as the monitor is turned on, Autofocus is enabled continuously regardless of whether the shutter is being pressed or not. The Focus is locked when the Shutter release button is pressed lightly. If the Monitor is turned off, <b>Single AF</b> is automatically selected until you turn it on again.
Single AF	Autofocus is only enabled when the Shutter release button is pressed lightly, regardless of the Monitor status.

### — Focus Confirmation —

This function allows you to check the Focus visually on the Monitor.

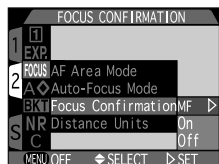

MF	In <b>MF</b> (Manual Focus) mode, the outline of the in-focus area of the image is emphasized in the Monitor as an aid to focus.
On	In all Focusing modes, the outline of the in-focus area of the image is emphasized on the Monitor.
Off	<b>Focus Confirmation</b> is canceled.

#### Check point

The outline of the focused image emphasized in **Focus Confirmation** mode is displayed only on the Monitor. It does not affect the recorded image.

### — Distance Units —

You can change the distance used on the Control panel and on the Monitor in **Manual Focus** mode.

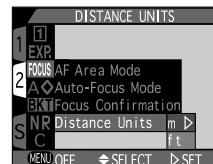

m	meters
ft	feet

## IMAGE SHARPENING

The camera can emphasize the details and borders of objects, making the picture appear sharper and bolder.

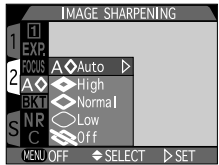

<b>Auto</b>	The camera automatically sets the sharpness.
<b>High</b>	Sets the Sharpness to high.
<b>Normal</b>	Sets the Standard sharpness.
<b>Low</b>	Sets the Sharpness to low.
<b>Off</b>	Cancels image sharpening.

Option	Description
<b>Auto</b>	The camera automatically sharpens the image for optimal results.
<b>Normal</b>	The same standard sharpness is set for all images.
<b>High</b>	The image is processed to increase the sharpness effect above the normal level, giving the edges of objects more emphasis and making details more distinct.
<b>Low</b>	The images processed to decrease sharpness below the normal level, making edges less distinct.
<b>Off</b>	No sharpening.

### Note: Image Sharpening setting

The Image sharpening setting does not affect the monitor display during shooting or the video output data.

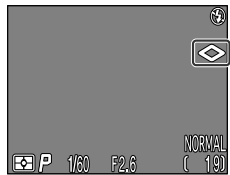

- The Image Sharpening indication is displayed on the Monitor when **High**, **Normal** or **Low** is set.

## AUTO BRACKETING

In situations where it might be difficult to obtain a proper exposure, Auto Bracketing lets you shoot the same subject at three or five different exposures. In WB Bracketing, the white balance is bracketed in three shots.

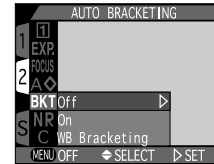

<b>Off</b>	Bracketing is off.
<b>On</b>	Auto Bracketing is set.
<b>WB Bracketing</b>	White Balance Bracketing is set.

Bracketing	Characteristics
<b>Off</b>	Bracketing is canceled and normal exposure control is used.
<b>On</b>	Auto Bracketing is performed with the selected number of bracketing shots and with a compensated EV value offset from the automatically metered exposure. The Shutter speed is bracketed in <b>P</b> , <b>A</b> or <b>M</b> Exposure modes and the aperture is bracketed in <b>S</b> Exposure mode.
<b>WB Bracketing</b>	The White Balance is bracketed when you press the Shutter release button fully giving 3 shots made up of one with the selected white balance, a reddish image and a bluish image. <ul style="list-style-type: none"> <li>The time required to save bracketed images to the CF memory card is three times that required for a normally recorded image.</li> </ul>

### — On —

Each time you press the Shutter release button, either three or five shots are taken ranging from over exposed EV values to under exposed EV values. When you shoot a high-contrast image, the image with the desired exposure can be selected from the set of bracketed shots.

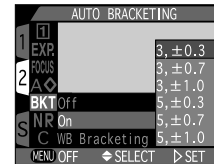

Number of shots, compensated EV value	Bracketing order
3, ±0.3	+0.3, 0, -0.3
3, ±0.7	+0.7, 0, -0.7
3, ±1.0	+1.0, 0, -1.0
5, ±0.3	+0.7, +0.3, 0, -0.3, -0.7
5, ±0.7	+1.3, +0.7, 0, -0.7, -1.3
5, ±1.0	+2.0, +1.0, 0, -1.0, -2.0

## Check point

To perform Auto Bracketing or White Balance Bracketing in **Continuous** or **VGA Sequence** mode (p. 99), hold down the Shutter release button fully. A selected number of consecutive shots are taken (up to three shots with **FULL, 3 : 2** and **Fine** mode), after which the sequence stops automatically.

- The Exposure Compensation indication  flashes on the Control panel and **BKT** along with the compensated EV value for the next shot are displayed on the Monitor when the bracketing is set.

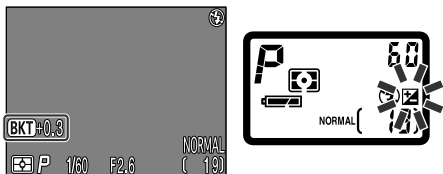

## — WB Bracketing —

White balance is bracketed when you press the Shutter release button fully, giving three shots made up of one shot with the selected white balance, one reddish image and one bluish image.

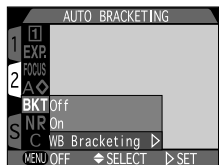

- When you select White Balance Bracketing, the **WB BKT** (White Balance Bracketing indication) appears on the Monitor.



## Notes: Auto Bracketing and White Balance Bracketing

- Bracketing cannot be set in **Multi-shot 16**, **Ultra HS**, **Movie** (p. 99), **Best Shot Selector** (p. 102), **AE Lock** (p. 109) or **Noise Reduction** mode.
- White balance bracketing cannot be set in **Continuous** mode other than **Single** (p. 99), **Best Shot Selector** mode, **AE Lock** mode or **Noise Reduction** mode .

## NOISE REDUCTION

When the camera is set for long time exposures, noise in the form randomly spaced bright-colored pixels will appear. The longer the exposure, the more this effect is apparent. The Noise Reduction setting can be used to minimize this effect.



<b>On</b>	The effect of noise on the recorded image is minimized.
<b>Off</b>	Noise reduction is canceled and normal exposure control is used.

## Note: Time taken to save an image to the CF memory card

When the **Noise Reduction** function is on, the time taken to save a picture to the CF memory card is approximately doubled.

## RESET ALL

The Reset all setting allows you to restore settings in all Shooting modes , and Playback to their default values.

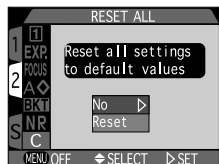

No	Exit menu without changing the settings.
Yes	Restore the settings to their default values.

When you perform **Reset All**, the camera settings are reset to the defaults shown below:

### Shooting menu

White Balance	Auto* <sup>1</sup>	Focus Options: AF Area Mode Auto-Focus Mode Focus Confirmation Distance Unit	Auto Continuous AF MF Not cleared
Metering	Matrix		
Continuous	Single		
Best Shot Selector	Off		
Image Adjustment	Auto	Image Sharpening	Auto
Saturation Control	Normal	Auto Bracketing	Off
Lens	Normal	Noise Reduction	Off
User Setting	Not cleared* <sup>2</sup>		
Exposure options: AE Lock Exposure Compensation Exposure Mode	Off 0 Not cleared		

\*<sup>1</sup> Fine-tuned values are also reset.

\*<sup>2</sup> Only the settings in the selected User Setting number is reset.

### Shooting SET-UP items

Folders	NIKON	info. txt	Off
Monitor Options: Display Mode Brightness Hue	On 3 6	Auto Off	30 S
		Seq. Numbers	Not cleared
		Date	Not cleared
Shutter Sound	On	Video Mode	Not cleared
Controls Memorize Func.1, 2	Cleared* Not cleared	Language	Not cleared
		Zoom Options Digital Tele Startup Position Fixed Aperture	On Last Position Off
Speedlight Options Variable Power Int Flash Off Shot Confirm Lamp	On Off Off	Disable delete	Off

### Playback Menu items

Folders	All Folders	Frame interval	3 S
---------	-------------	----------------	-----

### Playback SET-UP item

Video Mode	Not cleared
------------	-------------

### Functions set for each control

Functions set for each control (not on the Monitor) are not reset and remain in memory.

# Setting Shooting SET-UP Menus Shooting Mode

The SET-UP menu allows you to select various settings for basic camera setup before shooting, such as Monitor, Zoom and Speedlight options, etc.

## Displaying the SET-UP Menu

### In mode

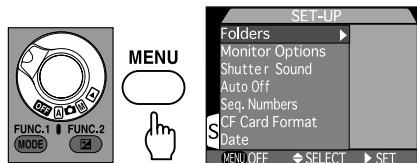

Set the Mode dial to  and press the MENU button to display the SET-UP menu on the Monitor.

• You can use the Multi selector to choose the desired menu item.





Folders	P. 122
Monitor Options	P. 125
Shutter Sound	P. 127
Auto Off	P. 127
Seq. Numbers	P. 128
CF Card Format	P. 129
Date	P. 129

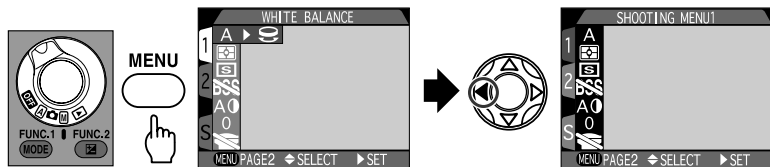

### In mode

1 Set the Mode dial to  and press the MENU button to display the Shooting menu. Use  on the Multi selector to select the Tab (S, 1 or 2).

• Pressing  in Shooting menu display turns the tab at the left of the display orange.



2 Select the S tab with  to display SET-UP 1 and press .

• SET-UP 1 appears at the top of the display when you press  to select the "S" tab at the left. Press  once to enable selection of the SET-UP items.

### SET-UP 1

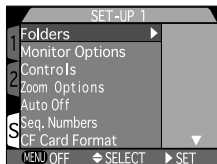

Folders	P. 122
Monitor Options	P. 125
Controls	P. 130
Zoom Options	P. 132
Auto Off	P. 127
Seq. Numbers	P. 128
CF Card Format	P. 129

3 Press  to display SET-UP 2 at the top of the screen.

• The 14 SET-UP items are divided into two displays. Press  on the Multi selector to move the cursor and display SETUP 2.

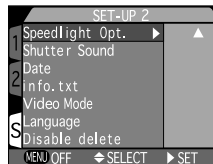

### SET-UP 2



Speedlight Opt.	P. 133
Shutter Sound	P. 127
Date	P. 129
info. txt	P. 134
Video Mode	P. 135
Language	P. 135
Disable delete	P. 135



## Choosing from the SET-UP Menus (example: Zoom Options)

1 Select the SET-UP menu item.

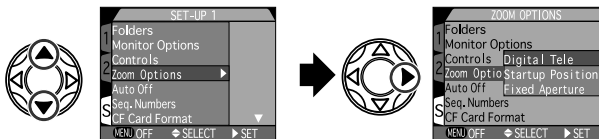
• Press  on the Multi selector to highlight the desired item and press  to display options for the selected item.



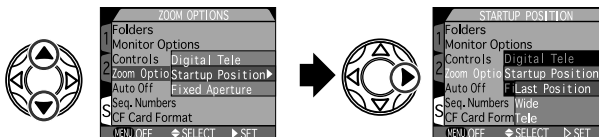

2 Select the option for the selected item.

• Press  to highlight the option and press  to display the detailed option menu.



3 Set the option and complete the setting by pressing the MENU button.

• Press  on the Multi selector to highlight the option and press  to set the option. Press the MENU button to complete the setting. The Monitor returns to the Shooting Mode.



## The Shooting SET-UP Items (in A mode)

### Folders

You can use this option to select new folders to help you organize your pictures on the camera for shooting and image playback. This feature allows you to create, rename and delete folders.

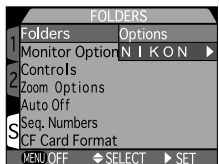

Options	Options for folder setup.
NIKON	Selects NIKON folder.
(Folder name)	Selects the newly created folder.

\* The NIKON folder is automatically created. Newly created folders are displayed below the NIKON folder.

### — Options —

Press  $\blacktriangle/\blacktriangledown$  on the Multi selector to select Options and then press  $\blacktriangleright$  to display the Options Menu.

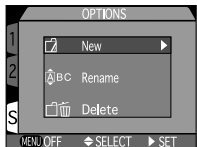

New	Creates a new folder.
Rename	Renames a folder.
Delete	Deletes a folder.

### [New]

Creates a new folder on the CF memory card.

1 Select "New" in the Options menu and press  $\blacktriangleright$  on the Multi selector. "NIKON" is displayed first.

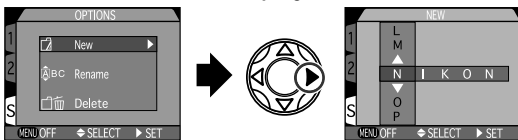

2 Press  $\blacktriangle/\blacktriangleright$  to highlight letter to be changed and press  $\blacktriangle/\blacktriangledown$  to edit selected letter. Repeat the procedure to create new five-letter folder name. Press  $\blacktriangleright$  to create new folder. The Monitor returns to the SET-UP menu.

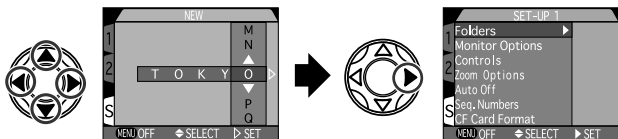

3 Press the MENU button to complete the setting.



• Folder name is shown on the Monitor when a folder other than NIKON is selected.

### [Rename]

Use this option to rename folder (other than the NIKON folder).

1 Select the "Rename" option and press  $\blacktriangleright$  on the Multi selector to display the folder list.

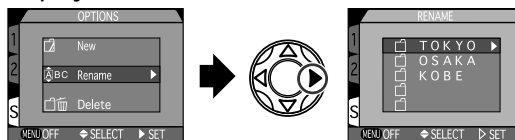

2 Press  $\blacktriangle/\blacktriangledown$  to select the folder to be renamed and press  $\blacktriangleright$  to display the name.

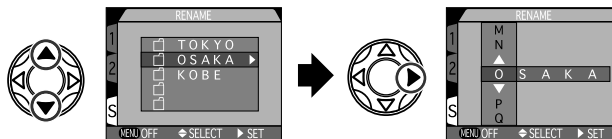

3 Press  $\blacktriangle/\blacktriangleright/\blacktriangle/\blacktriangledown$  to edit the name as described in the step 2 of "New" on p. 122. Press  $\blacktriangleright$  to rename existing folder. The Monitor returns to the SET-UP menu.

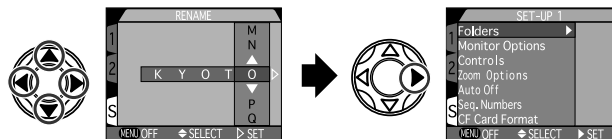

4 Press the MENU button to complete the setting.

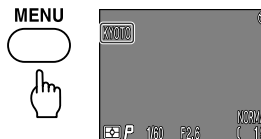

## [Delete]

This option enables you to delete folders (other than the NIKON folder).

- 1 Select “Delete” in Options and press on the Multi selector to display the folder list.

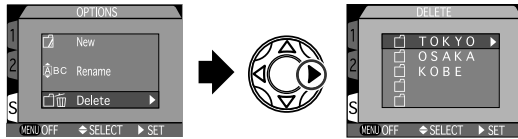

- 2 Press / to select the folder to be deleted and press to display the confirmation dialog box.

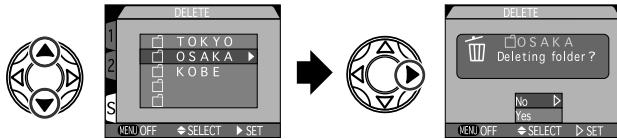

- 3 Press / to select “Yes” and then press to delete selected folder. The Monitor returns to the SET-UP menu. Press the MENU button to complete the setting.

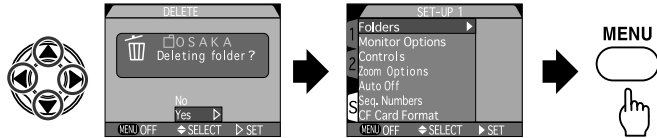

### Notes: Deleting folders

- The NIKON folder cannot be deleted.
- If the selected folder contains hidden or protected images, the folder will not be deleted. Any images it contains that are neither hidden or protected will, however, be deleted.

### — Selecting a folder —

Once additional folders have been created, you can select the folder that will be used for playback or to store photographs in and mode. Until a new folder is selected, all subsequent images will be stored in this folder, which will also be used for playback.



- Folder name shown in the Monitor (no folder name is displayed when NIKON folder is selected).

## Monitor Options

Use the Monitor Options sub-menu to specify when the Monitor will automatically turn on and to adjust the Monitor brightness and hue.

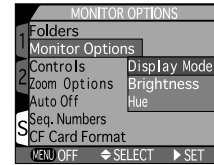

Display Mode (in  mode only)	Turns the Monitor and Preview mode On/Off
Brightness	Adjusts the brightness of the Monitor
Hue	Adjusts the hue of the Monitor

### — Display Mode (in mode only) —

Use this mode to set the Monitor operation mode. It can be set to On or Off, and you can also specify details such as whether images are displayed after shooting or displayed continuously in on the Monitor.

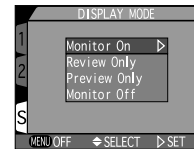

Monitor On	When the Mode dial is set to , the Monitor turns On.
Review Only	In  mode, the Monitor is normally Off but the recorded image is displayed after you release the shutter.
Preview Only	In  mode, the Monitor is normally On but the recorded image is not displayed after you release the shutter.
Monitor Off	When the Mode dial is set to , the Monitor turns Off. Before changing this setting, the Monitor must be turned On by pressing the MENU button.

### — Brightness —

This option adjusts the brightness of the Monitor through five levels.



Press or to increase or decrease the brightness of the Monitor by moving the arrow at the right side of the display up (brighter) or down (darker). Press to complete the Brightness setting and return to the SET-UP menu. Press the MENU button to complete this setting.

## — Hue —

The hue (overall color) of the Monitor can be finely adjusted to any of eleven levels.

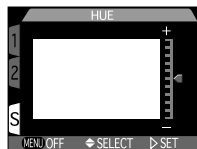



Press ▲ or ▼ to alter the hue by moving the arrow at the right side of the display up (reddish) or down (bluish). Once you have adjusted hue to your satisfaction, press ► to complete the hue setting and to return to the SET-UP menu. Press the MENU button to complete the setting.

### Selecting Brightness and Hue settings

The **Brightness** and **Hue** settings become effective as the arrow moves, allowing instant visual feedback on the changes in color and brightness.

### Check point

The adjusted **Brightness** and **Hue** are applied to all ,  and  modes.

## Shutter Sound

The camera has a small speaker to allow a confidence beep to indicate important operations like shutter release. With Shutter Sound menu, you can activate or cancel the camera's beep.



On	Turns the beep on
Off	Turns the beep off

### Beeps once to confirm

- Power is turned on in Shooting Mode.
- Shutter release button is fully depressed and the shutter is released.
- Completion of the following settings and preparations:  
**Lens, Manual Focus, CF Card Format, Delete, Protect, Hide Image, Print Set, Auto Transfer and Shutter Sound On.**

### Beeps twice to warn

- Image cannot be focused when the Monitor is turned off.
- CF memory card not is inserted or no more space is available on the CF memory card
- The battery is depleted.

## Auto Off

To extend battery life, the camera enters sleep mode if it is not used for 30 sec. (**Auto Power Off** function, p. 175). The time limit for sleep mode can be set in the "Auto Off" Menu.

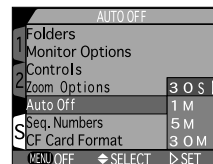

30S	30 seconds
1M	1 minute
5M	5 minutes
30M	30 minutes

### Check point

The **Auto-Off** duration is fixed at 30 minutes when the AC Adapter is connected. However, even after the **Auto-Off** time has elapsed, video signals will continue to be transmitted if a video cable is connected to the camera. In this case, only the Monitor turns off.



## Seq. Numbers

In order to avoid taking multiple pictures with the same file name (for example DSC0001.JPG), it is possible to allocate sequential numbers that are automatically assigned to image files. This feature can be used even when more than one CF memory card is used. This makes it easier for you to manage your files when you are downloading them to a computer as each file has a unique name.

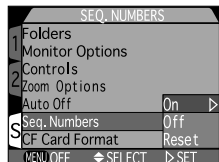

<b>On</b>	Sequential Numbers On
<b>Off</b>	Sequential Numbers Off
<b>Reset</b>	Resets the Sequential Numbers to 0001. If the number already exist, the sequential number is reset to the next number.

### Image file numbers and folder numbers

Four-digit numbers are assigned to image files recorded with the Nikon COOLPIX995, and file names from DSCN0001.JPG to DSCN9999.JPG are assigned to the files. Three-digit numbers are assigned to the folders in which these image files are to be saved. Since numbers 0001 to 9999 are automatically assigned to image files in each folder, it is possible for duplicate file names to exist when a large number of folders or CF memory cards are being used. When the **Sequential Numbers** setting is enabled, image file numbers are assigned sequentially even when you switch folders or CF memory cards, ensuring that image files are not created with duplicate numbers. This makes it easier for you to manage your files in situations such as when you are downloading all your files to a computer.

### Check point

When an image file number is greater than 9999 or the current folder contains more than 999 images, a new folder with a number one greater than the current folder is automatically created. Sequential numbers from 0001 are assigned to added image files.

## CF Card Format

Formats a CF memory card in the camera.



<b>No</b>	Does not format the CF memory card.
<b>Format</b>	Starts formatting the CF memory card.

### Notes: Formatting CF memory cards

- When Format is selected, all the pictures and data on the CF memory card are deleted. See page 38 for more information on formatting CF memory cards.
- When Format is selected and you press **▶** on the Multi selector, formatting starts and cannot be stopped. Do not try to remove the CF memory card during formatting.

## Date

The camera's date and time settings are saved with each picture. You can set the date and time when you use this camera for the first time and also change it if you travel to a different time zone on business or vacation.

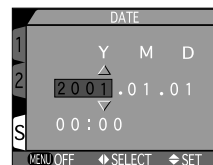

Year, Month, Day, Hour, Minute
Display sequence

- See page 32 for **Setting the Date/Time**.

## Shooting SET-UP Items (only in mode)

### Controls

You can use the **Controls** setting to specify whether individual functions are retained in the camera or cleared from the camera's memory when you turn the camera off. Various alternative functions can be selected and assigned to the FUNC. 1 (Exposure mode button) and FUNC. 2 (Exposure Compensation button).

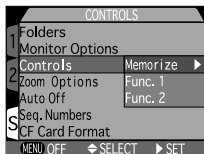

<b>Memorize</b>	Memorizes the settings that remain in camera's memory when the camera is turned off.
<b>FUNC. 1</b>	Pressing the MODE button activates the chosen alternate function.
<b>FUNC. 2</b>	Pressing the  button activates the chosen alternate function.

#### — Memorize —

The Memorize determines what settings remain in effect when the camera is turned off.

Any items that are not checked will be restored to default settings when the camera is turned off.

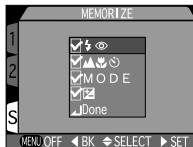

	Memorizes the flash mode setting.
	Memorizes the Focus mode setting.
<b>MODE</b>	Memorizes the Exposure mode setting.
	Memorizes the Exposure Compensation setting.
<b>Done</b>	Completes the setting.

To check an item, or to remove a check mark from an item that has already been checked, highlight the item and press **▶** on the Multi selector. Highlight "Done" and press **▶** to put the change into effect.

#### — FUNC. 1/FUNC. 2 —

By default, the **MODE** (FUNC.1) button controls exposure mode and the (FUNC. 2) button controls exposure compensation. Using the FUNC. 1 and FUNC. 2 menus, you can assign different functions to these buttons in mode.

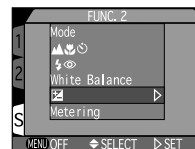
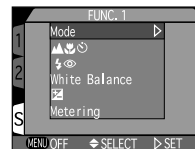

<b>Mode</b>	Assigns Exposure mode operation. FUNC. 1 default.
	Assigns Focus mode (including Self-timer and Manual focus) operation.
	Assigns Flash mode and ISO sensitivity operation.
<b>White Balance</b>	Assigns White Balance operation.
	Assigns Exposure Compensation operation. FUNC. 2 default.
<b>Metering</b>	Assigns Exposure Metering operation.

#### Check point

For even greater ease of use, when **White Balance** operation is assigned to the Exposure mode button or Exposure Compensation button using **FUNC. 1** or **FUNC. 2**, rotating the Command dial while pressing the button changes the display so that **PrE** (White Bal Preset), **Sun** (Fine), **Inc** (Incandescent), **Flu** (Fluorescent), **Clo** (Cloudy) or **FLa** (Speedlight) appears with the **W-BAL.** (White Balance) indication on the Control panel.

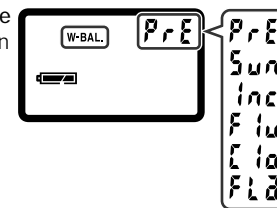

#### Setting FUNC. 1/2

- Press **▲/▼** on the Multi selector to highlight the selection and press **▶** to select. The Monitor returns to the SET-UP menu.
- Press the **MENU** button to complete the setting. The assigned function can now be activated using the FUNC. 1 (Exposure mode) button or FUNC. 2 (Exposure Compensation) button.
  - Operation after FUNC. 1 or 2 setting

Exposure mode, ISO Sensitivity, White Balance, Exposure Compensation, Exposure Metering	<b>MODE</b> +
Focus mode	<b>MODE</b>
Flash mode	

### Zoom Options

You can use the **Zoom Options** to determine various functions that relate to the initial set up of the lens and the aperture variations relative to the Zoom position.

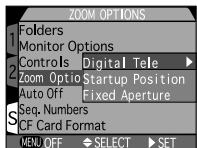

<b>Digital Tele</b>	Sets the Digital zoom setting.
<b>Startup Position</b>	Sets the initial Zoom position.
<b>Fixed Aperture</b>	Fixes the camera aperture during Zoom operation to ensure consistent exposure with external flash units.

#### — Digital Tele —

The Digital zoom function digitally enlarges the center of the image so that it fill the entire frame. The Digital Zoom only functions during shooting if the Monitor is turned on.

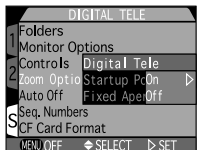

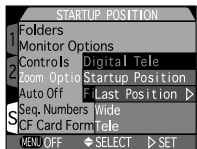

<b>On</b>	Hod down the  (optical) Zoom button for more than 2 sec. after the camera has reached its highest telephoto setting. The Digital zoom function (p. 63) then starts up automatically and the image in the Monitor is zoomed by up to 4.0x.
<b>Off</b>	Digital zoom function does not operate.

#### — Start-up Position —



<b>Last Position</b>	When you turn the camera on, the lens moves to its Zoom position at the time the camera was last turned off.
<b>Wide</b>	When you turn the camera on, the lens zooms in to the wide-angle setting.
<b>Tele</b>	When you turn the camera on, the lens zooms up to the telephoto setting.

- The start-up position for Zoom applies when shooting in both  and  modes.
- The start-up time is shortest for the telephoto Zoom setting.

#### — Fixed Aperture —

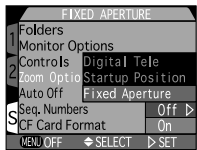

<b>Off</b>	Aperture varies with zooming.
<b>On</b>	In Aperture-Priority Auto or Manual Exposure mode, the camera memorizes aperture when zooming begins and the aperture value remains fixed throughout zooming. Note that with the fixed aperture setting, zooming may cause the exposure to exceed the exposure control range of this camera.

#### Note: Exposure in Fixed Aperture setting

Since the exposure will vary as the field of view changes, the exposure may exceed the control range of the camera when you use the zoom with the **Fixed Aperture** setting. To avoid this, use a **Fixed Aperture** setting of approx. f/5 to f/7.

### Speedlight Options

This menu controls settings for built-in Speedlight and for external Speedlights.



<b>Variable Power</b>	Adjusts flash output level.
<b>Int Flash Off</b>	Suppresses firing of the built-in Speedlight.
<b>Shot Confirm Lamp</b>	Turns the shot confirmation lamp on and off.

#### — Variable Power —

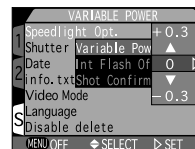

Flash output can be adjusted through 12 levels—from -2EV to +2EV in 1/3-EV steps.

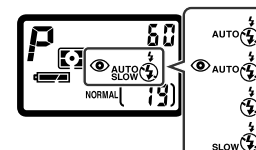
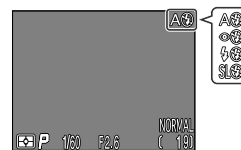
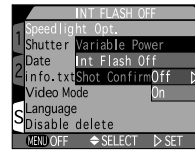

#### — Int Flash Off —

This setting allows you to take photographs with multiple external Speedlights. When the Int Flash Off setting is not selected, you can take pictures using multiple flash units, including both the built-in Speedlight and an optional external Speedlight. When this setting is selected, the built-in Speedlight flash is suppressed and only the optional external Speedlight(s) fire. In this situation, the flash modes for the optional Speedlights can be selected using the Flash mode button on the COOLPIX995 when the built-in Speedlight is raised.



- When **Int Flash Off** is set to **On**,  (optional Speedlight indication), the Flash mode indication for the optional Speedlight, and  (built-in Speedlight Flash suppressed) appear on the Control panel. The Flash mode indication for the optional Speedlight and  (built-in Speedlight Flash suppressed) also appear on the Monitor.

### Note: Activating an optional Speedlight

When you are using an optional Speedlight, be sure to raise the built-in Speedlight to ensure that the flash sync sensor is available.

### — Shot Confirm Lamp —

With the **Shot Confirm Lamp** setting **On**, the Red-eye reduction/Self-timer lamp next to lens lights each time a single picture is taken as a shot confirmation lamp.

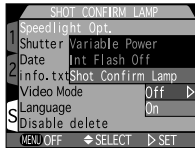

- The **Shot Confirm Lamp** setting becomes effective when a setting is selected by pressing  $\blacktriangle/\blacktriangledown$  on the Multi selector. Lightly pressing the Shutter release button activates the normal shooting display and the Monitor returns to the SET-UP menu when the shutter is released. Press the MENU button to complete the setting.

### info. txt

Image file numbers and a range of photography data are recorded as an independent text file. The file is located in the same folder as the image on the CF memory card.

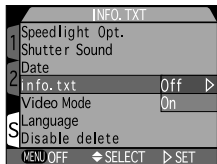

<b>Off</b>	Turns off the recording of text data.
<b>On</b>	Turns on the recording of text data.

- For more information, see **info. txt** on p. 160.

### Video Mode

You can set the video output mode to either **NTSC** or **PAL**.

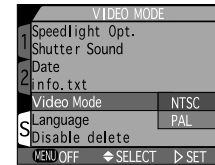

<b>NTSC</b>	Use when connecting to NTSC devices.
<b>PAL</b>	Use when connecting to PAL devices.

### Note: PAL video mode

When the video mode is set to **PAL**, the Monitor turns off during video connection.

### Language

Use the **Language** sub-menu to choose the language used in menus and messages displayed by the camera.



<b>D</b>	<b>German</b>
<b>E</b>	<b>English</b>
<b>F</b>	<b>French</b>
<b>J</b>	<b>Japanese</b>
<b>S</b>	<b>Spanish</b>

- For more information, see **Selecting a Language** on p. 32.

### Disable delete

You can use this option to disable the function that deletes all image files at a single command.



<b>On</b>	Activates the Disable Delete setting (images cannot be deleted).
<b>Off</b>	Deactivates the Disable Delete setting (images can be deleted).

### Note: Disable Delete

When **Disable Delete** is set to **On**, you cannot delete an image file with the Delete button or format a CF memory card.

The Playback mode has two pages of settings which are controlled from the Playback menu (Page 1) and Playback SET-UP menu screens. The Playback options enable you to delete photographs individually or as a selection (Delete), protect photographs from being deleted (Protect), hide photographs during playback (Hide Image), select a folder for playback (Folders), show the pictures in a sequence as a slide show (Slide Show) and prepare photographs for printing (Print Set). The Nikon View 4 software (which allows you to copy images from your camera or CompactFlash™ card to a computer) can be set to transfer an image based on Protect or Auto Transfer being either set or not.

## Displaying the Playback Menu

Set the Mode dial to and press the MENU button to display the Playback menu on the Monitor.

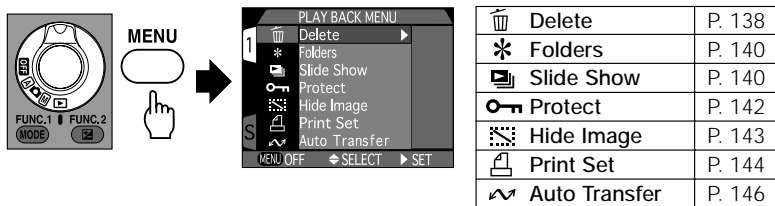

	Delete	P. 138
	Folders	P. 140
	Slide Show	P. 140
	Protect	P. 142
	Hide Image	P. 143
	Print Set	P. 144
	Auto Transfer	P. 146

## Choosing from the Playback Menu (example: Delete)

### 1 Select the menu item.

- Press ▲/▼ on the Multi selector to highlight the desired menu item and press ► to display options for the selected item.

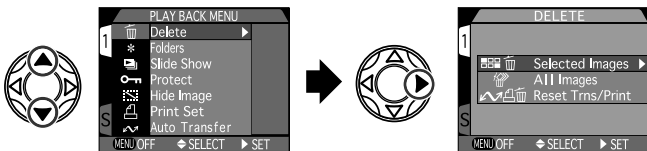

### 2 Select the option for the item.

- Press ▲/▼ to highlight the desired menu option and press ► to display either the confirmation dialog, detailed option menu or thumbnails to be selected, depending on the particular item.

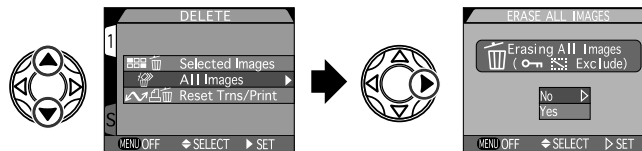

### 3 Set the option.

- Press ▲/▼ to highlight the option and press ► to confirm. The Monitor then returns to the Playback menu. Press the MENU button to complete the operation.

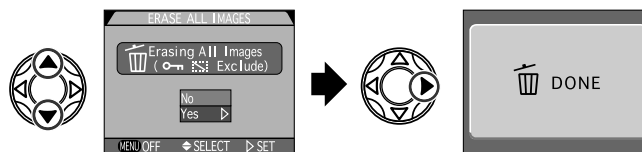

## Check point

In Playback there is a SET-UP page and one further Playback menu. When you press the MENU button, page one of the Playback menu is displayed. To get to the SET-UP page, press ◀ on the Multi selector to turn the white "Page 1" tab orange, then press ▲/▼ on the Multi selector to highlight the "S" SET-UP tab. Press ► once to enable selection of the SET-UP items.

## Playback Menu

### Delete

Saved photographs, the settings of Auto Transfer and Print-order files can be deleted. With the Delete option in the Playback menu, it is possible to delete either selected photographs from the thumbnail pages or alternatively all the photographs on the CF memory card (except Hidden and Protected).



### — Deleting selected photographs —

To delete selected photographs, choose Selected Images from the Delete sub-menu.

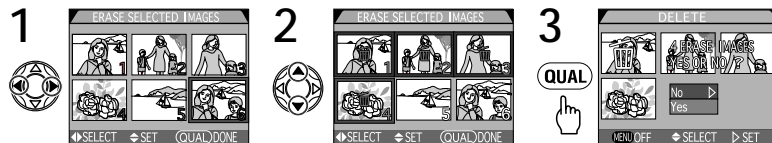

- 1 Press ◀/▶ on the Multi selector to highlight (with the orange frame) the desired images to be deleted.
- 2 Press ▲/▼ to select the images to be deleted (the delete appears).
  - To cancel the selection and make the Delete icon disappear, press ▲/▼ on the selected image again.
- 3 Press the **QUAL** button. The Delete confirmation dialog appears. Press ◀/▶ to select “Yes”, (or “No” to abort) then press ▶ to delete all selected images.
  - Continue selecting images and then confirm your selection by pressing the **QUAL** button.

#### Notes: Images with Protect or Hide Image setting

- The protected image(s) are displayed in the thumbnail menu but cannot be selected.
- Images with **Hide Image** settings are not displayed in the thumbnail menu.

### — Deleting All Images —

Select All Images and Yes in the confirmation dialog to delete all photographs on the CF memory card.

- 1 Press ▲/▼ on the Multi selector to select “Yes” in the Delete confirmation dialog.
- 2 Press ▶ to delete all images.

#### Note: Deleting All Images

- Images with the **Protect** or **Hide Image** setting are not deleted.
- All the images are deleted but the folders are not deleted.

### — Reset Trns/Print —

The settings of the Auto Transfer option (p. 146) can be reset, and Print-order files created with the Print Set option (p. 144) in the Playback menu can be deleted. Saved photographs are not deleted.

- 1 Press ▶ on the Multi selector to reset the Auto Transfer setting and delete Print-order Files.

## Folders

The **Folders** option in the **Playback** menu can be used to select images in all folders for playback, or only images in a selected folder. This menu also contains options for creating, renaming and deleting folders.

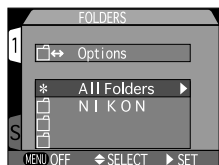

	<b>Options</b>	Options for folder setup.
	<b>All Folders</b>	Selects All Folders.
	<b>NIKON</b>	Selects the NIKON folder.
	<b>(Folder name)</b>	Selects newly created folder.

\* A NIKON folder is automatically created. Newly created folders are displayed below the NIKON folder.

- For **Folders Options**, see page 122.
- Select a folder to be played back from **All Folders**, **NIKON** or from a newly created folder.
- The **All Folders** option enables you to view images in all folders without having to select individual folders.

## Playback of photos taken in Ultra HS mode

Photos taken in the **Ultra HS** mode are stored in a separate folder with a name consisting of "N\_" followed by a three-digit number assigned by the camera. To view photographs taken with this setting, select **All Folders** or the appropriate folder from the **Folders** menu.

## Slide Show

The **Slide Show** option in the **Playback** menu allows the photographs in a folder to be played back in an automatic sequence as a slide show. All photographs in the current folder that have not been hidden using **Hide Image** will be played back one after another. Each image is displayed for a pre-set time interval.

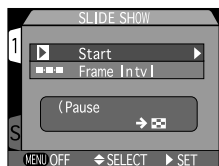

	<b>Start</b>	Starts a Slide Show
	<b>Frame Intvl</b>	Changes the display time interval

## — Start —

Press **▲/▼** on the **Multi selector** to select "Start", then press **▶** to display photographs in sequence on the **Monitor**.

- Photographs are displayed one by one, from the first photo to the last one. After the last photograph is displayed, the slide show is paused.
  - Any movies in the slide show will be played back as still images showing the first frame of the Movie
  - Press the **Thumbnail button** to pause the slide show at any time.
  - Press the **MENU** button to end the slide show and return to Full-frame playback.
  - Pressing the **Multi selector** during the slide show advances or rewinds the show by one frame for each press.
  - The **Monitor** is automatically turned off 30 minutes after the last command.
- To change the display time interval in the **Frame Intvl** sub-menu or from the **Pause** screen, press **▲/▼** on the **Multi selector** to select **Frame Intvl**, then press **▶** to display the **Frame Intvl** option.

## — Frame Intvl —

Press **▲/▼** on the **Multi selector** to select **Frame Intvl** from the **Slide Show** sub-menu or from the **Pause** screen, then press **▶** to start (or restart) the slide show with the selected interval.

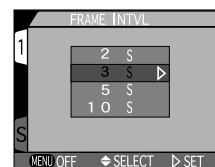

- The display interval is the minimum length of time for which each image is fully displayed. The default setting of the display interval is 3 seconds. Selectable intervals are 2, 3, 5, and 10 seconds.
- Depending on the file size of the images in the slide show, the actual interval may differ from the selected interval. Large files may take longer to load from the CF card memory than the interval setting.

## After the slide show is finished:

- Press the **MENU** button to return to the Full-frame playback display.
- Press **◀** on the **Multi selector** to return to the **Playback** menu.

## Protect

The **Protect** option can be used to prevent recorded images in the CF memory card from being deleted.



### — Protecting selected images —

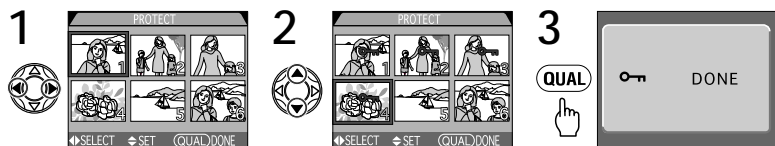

1 Press on the Multi selector to highlight a desired Thumbnail.

2 Press to select an image to be protected.

- Selected images are marked by the **Protect** icon. By pressing again on the image, the selection is canceled and disappears.

3 Press the **QUAL** button to give all selected images the Protect attribute.

- Continue selecting images and then press the **QUAL** button to confirm your selection.
- Once selected images have been protected, a confirmation appears on the Monitor which then returns to the **Playback** menu.

### — Cancel protection on images —

1 Press on the Multi selector to highlight the thumbnail of the image for which you want to cancel protection. Press to cancel protection of the selected image (the **Protect** icon disappears).

2 Press the **QUAL** button to implement the setting.

## Hide Image

When creating a slide show or showing photographs to an audience, you may want to use the **Hide Image** option to hide some of the photographs in the current folder from view. Hidden images are only visible in the **Hide Image** Menu. They cannot be deleted in Full-frame playback or from the **Delete** sub-menu.



### — Hiding selected photographs —

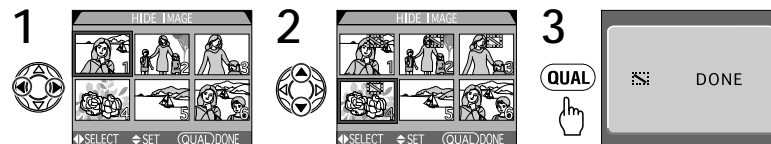

1 Press on the Multi selector to highlight the Thumbnail image to be hidden.

2 Press to select the image.

- Selected images are marked by the **Hide Image** icon. To deselect, press on the Multi selector.
- Repeat steps 1 and 2 to select/deselect further images.

3 Press the **QUAL** button to complete the operation.

- The selected images have been hidden. A confirmation appears on the Monitor which then returns to the **Playback** menu.

### — Canceling hiding of images —

1 Press on the Multi selector to highlight the Thumbnail image that has been selected to be hidden. Press to cancel the **Hide Image** setting of the selected image (the **Hide Image** icon disappears).

2 Press the **QUAL** button to complete the operation.



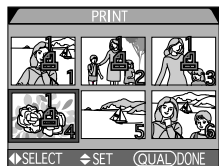

## Print Set

The Digital Print Order Format (DPOF) allows images to be marked for printing at a Lab, Print Shop or on a desktop Printer that can read the DPOF information. As well as the instruction to print the image, the DPOF system also allows the number of prints to be specified and whether or not the image date and/or other information should appear. This Digital Print Order Format information is stored on the CF memory card.

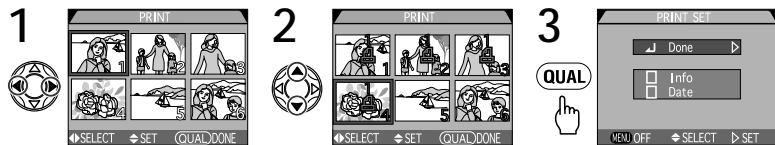

### — Selecting images to be printed and designating print status —



- 1 Press **◀/▶** on the Multi selector to highlight the desired Thumbnail.
- 2 Press **▲/▼** on the Multi selector to select an image to be printed and to set the number of prints.
  - Selected images are marked with the  icon and the number of prints is displayed on each selected image. Press **▲** on the Multi selector to increase the number of prints (up to nine) or **▼** to decrease the number of prints.
  - Repeat steps 1 and 2 to select more images.
- 3 Press the **QUAL** button. The setting is completed and the Monitor returns to the display of Print options.

### — Print Set options —

You can specify whether to print recording date, shutter speed and aperture on all selected photographs.

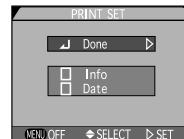

<b>Done</b>	Complete print order.
<b>Info</b>	Specify whether to print shutter speed and aperture on all selected photographs.
<b>Date</b>	Specify whether to print date of recording on all selected photographs.

#### Done

Press **▲/▼** on the Multi selector to select **Done**, then press **▶** to complete print order. The Monitor shows **Done**, and then returns to the **Playback** menu.

#### Info

Press **▲/▼** on the Multi selector to select **Info**, then press **▶** to check or uncheck the item. If the item is checked, shutter speed and aperture will be printed on all selected photographs.

#### Date

Press **▲/▼** on the Multi selector to select **Date**, then press **▶** to check or uncheck the item. If the item is checked, the date of recording will be printed on all selected photographs.

### — Cancel print order on images —

- 1 Press **◀/▶** on the Multi selector to highlight the Thumbnail for which you want to cancel the print order. Press **▼** to cancel the print order on the selected image.
  - Pressing **▼** on the image with the Print  icon decreases the number of prints. By pressing **▼** when the number of prints is "1", the print order is canceled.
- 2 Press the **QUAL** button to complete the operation.

#### Check point

To delete print-order files, select **Reset Trns/Print** from the **Delete** sub-menu. See p. 139.

#### Digital Print Order Format (DPOF)

The print orders and the number of prints are stored on the CF memory card in Digital Print Order Format (DPOF). The card can then be removed from the camera and inserted in a DPOF-compatible device — either your personal photocopier or a photofinisher's print system — and the selected images printed directly from the card.

## Auto Transfer

The Auto Transfer setting controls whether or not the Nikon View 4 software will automatically copy selected images to a computer when the camera is connected by the USB cable.



Selected Photos	Only selected images will be transferred.
All Photos	All images will be transferred.

### — Setting Auto Transfer —



1 Press on the Multi selector to highlight the desired images.

2 Press to select the images to be transferred.

- Selected images are marked with the Auto Transfer icon. To deselect, press on the Multi selector.

3 Press the button to complete the operation.

### — Canceling auto transfer —

1 Press on the Multi selector to highlight (with orange frame) the thumbnail image for which you want to cancel auto transfer. Press to cancel the Auto Transfer setting.

- The Auto transfer setting is canceled and disappears.

2 Press the button to complete the operation.

### — Transferring all images —

To set all image files to be transferred, select All Photos.



1 In the confirmation dialog for transfer of all images, press on the Multi selector to highlight “Yes”.

2 Press to execute.

In the Playback SET-UP menu, you can make changes to basic camera settings and perform tasks such as formatting memory cards.

## Displaying the Playback SET-UP Menu

1 In Playback mode, press the MENU button to display the Playback menu and press on the Multi selector.

- Pressing highlights (indicated in orange) the tab at the left.

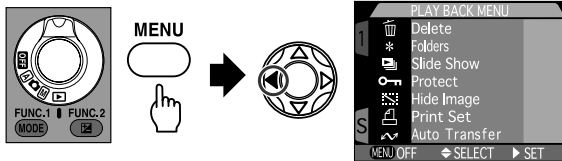

2 Press to select the "S" tab ("SET-UP" is displayed at the top) and press to activate the Playback SET-UP menu.

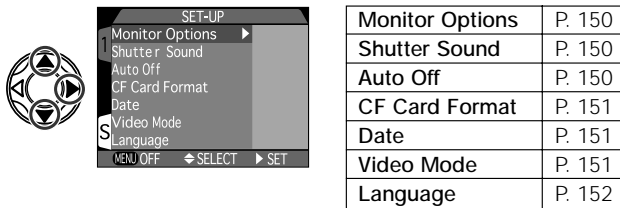

## Choosing from the Playback SET-UP Menu (example: Monitor Options)

1 Select the Playback SET-UP menu item.

- Press on the Multi selector to highlight the desired menu item, then press to display options for the item.

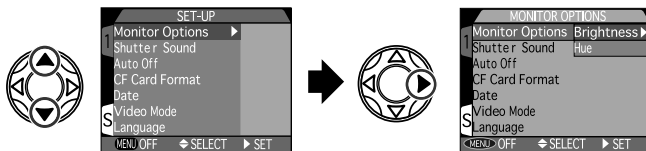

2 Select the option for the selected item.

- Press to highlight the desired option, then press to display option details.

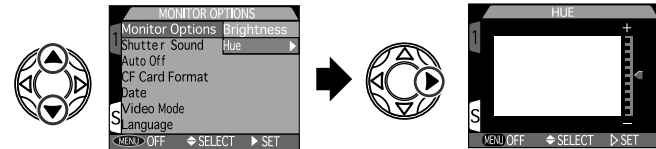

3 Set the option.

- Press to highlight the desired option, then press to set. The display returns to the Playback SET-UP menu. Press the MENU button to complete the operation.

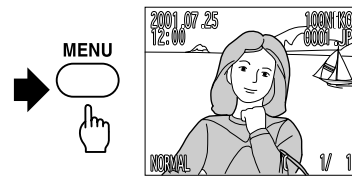
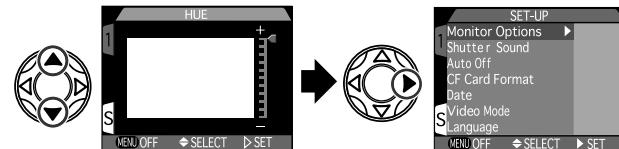

## Playback SET-UP Menu items

### Monitor Options

The hue (overall color) and brightness of the Monitor can be adjusted to improve visibility.

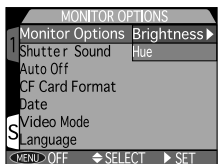

Brightness	Adjusts Monitor brightness
Hue	Adjusts overall Monitor color

- For setting **Monitor Options**, see **Monitor Options** in **Shooting SET-UP** on p. 125.

### Shutter Sound

The camera has a small speaker to provide a “confidence” beep to indicate important operations like shutter release. You can use the Shutter Sound menu to activate or cancel the camera’s beep.

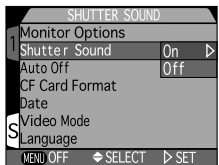

On	Turns on the beep
Off	Turns off the beep

- For setting shutter sound, see **Shutter Sound** in **Shooting SET-UP** on p. 127.

### Auto Off

To extend battery life the camera turns off after a preset time of inactivity. This time is set with the Auto Off menu.

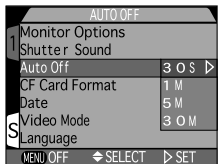

30S	The Monitor automatically turns off after 30 sec.
1M	The Monitor automatically turns off after 1 minute.
5M	The Monitor automatically turns off after 5 minutes.
30M	The Monitor automatically turns off after 30 minutes.

- The **Auto Off** function for Playback mode can be set independently from the **Auto Off** for the Shooting mode. For detailed information about the **Auto Power Off** function, see p. 175.
- For setting auto power-off, see **Auto Off** in **Shooting SET-UP** on p. 127.

### CF Card Format

Formatting a CF memory card erases all pictures and data to allow the maximum space to be recovered for use again in the camera.

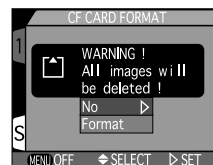

No	Does not format the CF memory card.
Format	Starts formatting the CF memory card.

- For information on how to format CF memory cards, see p. 38.

### Date

The camera’s date and time setting are saved with each picture. The Date and Time menu allows the date and time to be set to your local time zone.

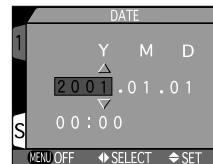

- For information on **Setting Date/Time**, see p. 34.

### Video Mode

The COOLPIX995 supports the two principal worldwide TV standards. You can choose either the NTSC or PAL standard for video output.

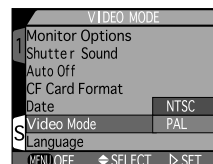

NTSC	Selects the NTSC standard (Japan, USA).
PAL	Selects the PAL standard (Europe, Oceania).

- For information on setting video mode, see **Video Mode** in **Shooting SET-UP** on p. 135.

## Language

The camera menus and messages can be viewed in one of a number of languages.

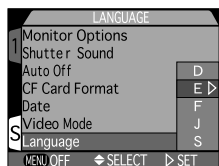

D	German
E	English
F	French
J	Japanese
S	Spanish

- For information on **Selecting a Language**, see p. 32.

# Connections

This chapter provides information on connecting your camera to an AC adapter (available separately), to a computer, and to a television or videocassette recorder (VCR).

## Connecting to an AC Adapter (optional)

The camera can be powered from AC electrical outlets rated at 100–240 V 50/60Hz using the EH-21 AC adapter/battery charger (8.4V, 1.3A).

- 1 Open the DC-in connector cover as indicated.

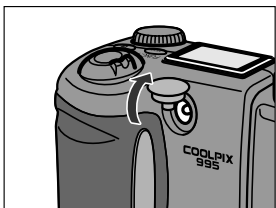

- 2 Set the Mode dial to **OFF**, and connect the AC adapter plug to the DC-in connector.

- 3 Plug in the adapter.

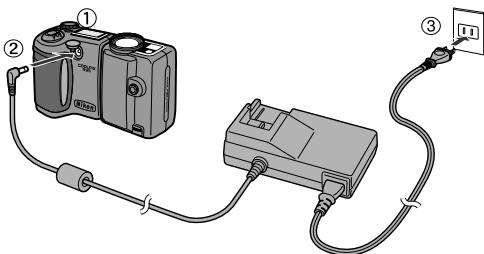

- The EN-EL1 rechargeable Li-ion battery can be charged with the EH-21 AC adapter/ battery charger.
- The EN-EL1 rechargeable Li-ion battery cannot be charged when it is installed inside the camera.

### Notes: Connecting the AC adapter

- When connecting or removing the AC adapter plug, make sure that the Mode dial is set to **OFF**.
- Use only the Nikon Accessory EH-21 AC adapter/battery charger.
- The camera and the AC adapter may become warm when plugged in for a long time. This is not a malfunction.
- When taking pictures with the AC adapter connected, make sure that the adapter cord does not get in front of the lens, Speedlight or the flash sync sensor.

## Connecting to a television or VCR

You can connect the COOLPIX995 to a television or VCR to display images on a TV monitor or make a recording on a VCR using the provided video cable.

- 1 Open the Video output connector/USB connector cover as shown.

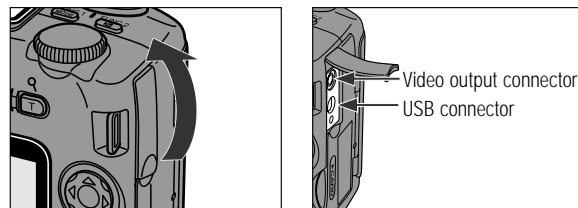

- 2 Connect the video cable provided.

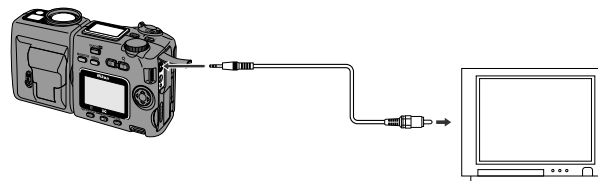

- Insert the black plug on the video cable into the camera's video output connector, and connect the yellow plug to the video-in jack on the television or VCR. Note that the Video input connector is not the same as the connector used to connect your TV or VCR to an antenna or aerial.
- When the Monitor is turned off, shooting (text) information will not be displayed on the television screen.
- To prevent the camera from turning off during extended Video viewing or recording, use the optional AC adapter.
- Auto Power Off (p. 175) for the Monitor is fixed at 30 minutes when the AC adapter is connected. However, when the video cable is connected, the COOLPIX995 will not turn off automatically and the video output will continue until the camera is turned off manually.
- The **Video Mode** item in the **SET-UP menu** (p. 135) offers a choice of NTSC and PAL standards for video output. Select a standard that matches that used in your television set. Note that when the PAL video standard is selected, the Monitor will turn off when the camera is connected to a video device. While recording in **Ultra HS** or **Movie** mode (p. 99), the Monitor will be used for display and video output will be suspended.

# Connecting to a computer

Although it is not necessary to own or use a computer to enjoy digital images from your COOLPIX, a computer greatly enhances the range of possibilities and uses for digital photography. With the aid of a computer, you can view the images stored in the CF memory card, apply creative effects using your favorite imaging application, create a valuable store of photographs on your hard disk and share them by E-mail or on the Internet. The COOLPIX995 is equipped with a Universal Serial Bus (USB) for Windows® 2000, Me and 98/98SE, and Macintosh OS 8.6/9 operating systems that is capable of direct connection to your computer via a USB cable. Alternatively, you can insert the CF memory card in a PC card slot or CompactFlash™ card reader, where it will function as an additional disk.

- By using the Nikon View 4 software provided, images stored in the memory card or camera can be conveniently checked and selected for copying to your computer. The process is made simple by being able to view the images in a variety of sizes, rotate them and rename them prior to copying.
- Before using Nikon View 4, read the provided "Nikon View 4 Guide".
- If transferring a large number of images, the use of the AC adapter (optional) is recommended to prevent the camera from turning off unexpectedly.

## Note: Transferring image data

For owners of more than one type of Nikon digital camera, please note that the COOLPIX995 can only transfer pictures that have been taken with the COOLPIX995, 990, 950, 880, 800, 700, 900s and 900 models. It is not possible to transfer images back to the camera. It may also not be able to display files that have been renamed or moved to a different folder on the CF memory card using a computer.

## Connecting to a Computer via the USB Interface

- 1 Open the Video output/USB connector cover and connect the COOLPIX995 and computer using the USB cable provided.

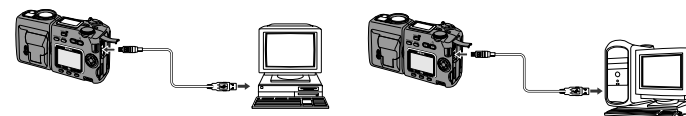
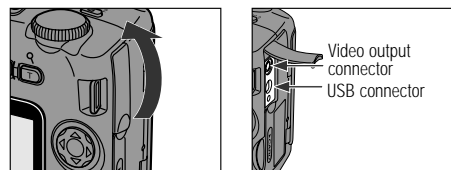

Connecting to Windows®-compatible computer

Connecting to Macintosh computer

- The COOLPIX995 and computer do not have to be turned off when connecting via a USB interface.
- Connection of the camera to the computer is confirmed by an animated rectangular display in the Control panel (☐).

## Note: USB hub

Nikon cannot guarantee the COOLPIX995's performance when it is connected to a USB hub.

- 2 Complete the Connection session.

- Copying image data may take some time: please check the Nikon View 4 progress bar to ensure that all activity has ceased before disconnecting the camera from the computer.

## Note: Disconnecting the camera from the computer

With Windows: Click the "Unplug or Eject Hardware" icon in the taskbar and remove the camera or memory card from the system.

With Macintosh: Drag the "untitled" volume corresponding to the camera or memory card into the Trash.

# Connecting to a computer—continued

## Note: Operation when connected to a computer

Do not turn the Mode dial to OFF while data transfer between the camera and the computer is in progress (indicated by the progress bar in Nikon View 4 on your computer screen). Failure to observe this precaution might result in unexpected problems such as software malfunction, damage to the copied picture, or camera malfunction.

## Check point

When you connect your camera to a computer, the computer must complete a process called “registration” in order to know how to communicate with the device in the correct manner.

With **Windows®Me** or **Windows®2000**, when you connect the camera and the computer via a USB cable for the first time, the required driver software will be automatically installed to your computer, and the computer automatically registers the camera as a “COOLPIX995” (see the Windows® Device Manager in your computer).

To register your camera on a computer running **Windows®98/98SE**, the required driver software can be found on the Nikon View 4 CD-ROM. Please make sure that you have the CD-ROM in your computer’s CD-ROM drive when you first connect the camera. Note that Windows®95 and Windows®NT do not support USB.

With Macintosh **OS 8.6** or **OS 9**, the “untitled” volume corresponding to the camera is automatically displayed on the desktop. Note that users of Mac OS 8.6 will need to upgrade to version 1.3.5 of the Apple Computer USB driver. Nikon View 4.0 will by default automatically start as soon as the camera is connected.

## DCF

The COOLPIX995 conforms to the Design rule for Camera File system (DCF) format. The DCF is a widely adopted image format standard enabling the shared use of image data from different digital camera manufacturers.

## Reading Photographs from Memory Cards

There are a number of different types of memory card in use with digital cameras. The COOLPIX uses the small CF (CompactFlash™) format memory cards which are about the size of a book of matches, and accepts Type II CF cards, which are slightly thicker, as well as Type I CF cards. Current laptop computers are generally equipped with PC card slots which are electrically the same as CF, but are about the size of a credit card. A simple, optional inexpensive adapter (EC-AD1) is available from Nikon, and this takes a Type I CF card and allows it to fit into a PC card slot. If you are using Type II CF cards, make sure that your adapter is compatible. Alternatively a CF card reader may be used. There are CF card readers for both Type I and Type II formats, and for a variety of connections to the computer, including Parallel, USB and SCSI.

.....  
**1** Insert the CF memory card into the EC-AD1 PC-card adapter, CF card reader etc. of your computer.

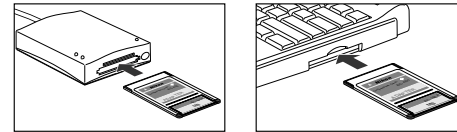

- For details on insertion, read the instruction manuals provided with the computer or card reader.
- The steps involved in connecting a card drive and inserting CF memory cards are covered in the instruction manual for the computer or operating system.

**2** Nikon View 4 will by default automatically begin and allow image files on the CF memory card to be checked and copied to your computer.

- The CF memory card will now function as an additional drive of the computer.
- In standard situations where setting (creating a new folder, changing name) is not selected at **Folders** in the **Shooting menu**, the following folders and image files are stored in the memory card.

Image files may be found in the 100NIKON folder which is in folder (directory) DCIM in the root directory. The image files are named DSCN0001.JPG, DSCN0002.JPG, DSCN0003.JPG, etc.

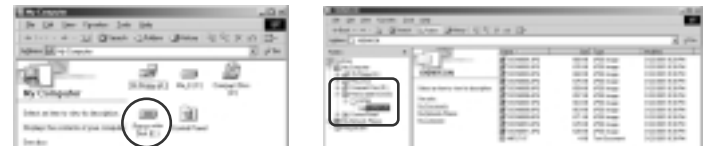



## Image files and folders—naming

DSCN: Image file name given by the COOLPIX995

DSCN0001.JPG

0001: Image file number (0001 to 9999)

JPG: Extension  
.JPG: JPEG format  
.TIF: TIFF format (HI mode)  
.MOV: Movie format

- Image file names created by the camera are named DSCN0001.JPG to DSCN9999.JPG within a given folder. If and when the image file number in the 100NIKON folder reaches 9999, the COOLPIX995 automatically creates a new folder called 101NIKON, and in that folder, new image files starting from DSCN0001.JPG are stored.
- Images are stored in RGB TIFF (Red, Green and Blue Tagged Image File Format) format when the image is taken in **HI** (no compression) mode. TIFF files are not compressed and represent the highest possible Image quality.
- Images are stored in MOV (QuickTime Movie) format when the images are taken in **Movie** mode (p. 83).

### info.txt

A separate text file, called **info.txt**, is automatically created in the same folder as the images if the **info.txt** menu in the **SET-UP menu** is set to **On** (p. 134). The **info.txt** file contains the following data about each picture in the folder:

DSCN0001.JPG (Example): File name and type  
CAMERA: Camera type and firmware version  
METERING: Metering mode  
MODE: Exposure mode  
SHUTTER: Shutter speed  
APERTURE: Aperture  
EXP +/-: Exposure Compensation  
FOCAL LENGTH: Focal length and Digital zoom factor  
IMG ADJUST: Image adjustment  
SENSITIVITY: Sensitivity (ISO equivalency)  
WHITEBAL: White balance  
SHARPNESS: Sharpening  
DATE: Date of recording  
QUALITY: Image size and quality  
SATURATION: Saturation control  
FOCUS AREA: Focus area

- **info.txt** can only be viewed when the CF memory card is directly read to the computer and is not available when connecting the camera by USB. However, Nikon View 4 can copy this information into a special part of the image file called the IPTC text. This information can be read in certain applications such as Fotostation and Photoshop (Full versions). To read this picture data when connected by USB, set Nikon View 4 to copy the "Exif" data into the Caption field of the IPTC test area. This information does NOT appear in the image.

# Miscellaneous

This chapter provides information on optional accessories and advice on troubleshooting, and lists the specifications of the camera.

# Optional Accessories

## Wideangle Converter WC-E63

When the WC-E63 is attached to the COOLPIX995, the focal length is reduced by a factor of 0.63X. The combined focal length becomes 5.0mm (35mm [135] format equivalent to approx. 24mm) The combined f-number becomes f/2.6.

## Fisheye Converter FC-E8

When the FC-E8 is attached to the COOLPIX995, the focal length of the lens is reduced by a factor of 0.21X. The picture angle extends to become 183 degrees, making the image spherical. The combined focal length becomes 1.7mm (35mm [135] format equivalent to approx. 8mm). The combined f-number becomes f/2.6.

## Telephoto Converter TC-E3ED

When the TC-E3ED is attached to the COOLPIX995, the focal length is extended by a factor of approximately 3X. The combined focal length becomes 96mm (35mm [135] format equivalent to approx. 456mm) and the combined f-number becomes f/5.1.

## Telephoto Converter TC-E2

When the TC-E2 is attached to the COOLPIX995, the focal length is extended by a factor of approximately 2X. The combined focal length becomes 64mm (35mm [135] format equivalent to approx. 304mm) and the combined f-number becomes f/5.1.

## Multi-Flash Bracket Unit SK-E900/TTL Multi-Flash Adapter AS-E900

This bracket unit is used to attach an optional Nikon Speedlight to the COOLPIX995 for multiple-flash photography. The amount of light from the built-in and external Speedlights is controlled by the sensor in the COOLPIX995, making multiple-flash photography simple and reliable.

## Remote Cord MC-EU1

This controller is attached to the COOLPIX995 for remote shooting and playback. In addition to the shutter release, the controller has buttons to adjust Zoom, set and take interval photography and playback images. Through the display, it is possible to confirm the most important camera status items such as Exposure mode and the number of remaining exposures available.

## Slide Copy Adapter ES-E28

The ES-E28 for the COOLPIX995 is designed to facilitate copying of 35mm film. It screws onto the front of the lens, and with the dedicated camera setting, the camera automatically adjusts the focus.

## PC Card Adapter EC-AD1

The EC-AD1 PC Card Adapter allows a Type I CompactFlash™ card to be used in a PC Card slot.

## AC Adapter/Battery Charger EH-21

This AC adapter is designed for COOLPIX cameras that use the Li-ion Rechargeable Battery EN-EL1. AC Adapter/Battery Charger EH-21 can also charge the Li-ion Rechargeable Battery EN-EL1.

\* The AC Adapter EH-31/30 cannot be used with the COOLPIX995.

## CompactFlash™ card EC-CF series

CompactFlash™ memory cards are available in a variety of capacities. Choose a memory card which has adequate storage for your needs.

## Usable CF memory cards

Nikon EC-CF series CompactFlash™ cards have been rigorously tested and certified by our quality assurance process. Operation with the following memory cards of other manufacturers has also been certified:

SanDisk: SDCFB-16, SDCFB-32, SDCFB-48, SDCFB-64, SDCFB-96, SDCFB-128  
LEXAR MEDIA: 10X USB Series: 128MB, 160MB  
8X USB Series: 8MB, 16MB, 32MB, 48MB, 64MB, 80MB  
4X USB Series: 8MB, 16MB, 32MB, 48MB, 64MB, 80MB

\* For detailed functions and operations with the above CF memory cards, please contact the manufacturer.

- The COOLPIX995 is physically and electrically compatible with all CF Type I and Type II memory cards. However, the demands placed on the memory cards by a digital camera are very high, due to the large volume of data and the speed at which pictures are copied. Some lower-grade CF memory cards may therefore prove unreliable over time.

### Notes: Using CF memory cards

- The CF memory card may become warm after extended use in the camera. Be careful when removing cards that have become warm.
- Format CF memory cards before first use.
- For information on formatting CF memory cards, see p. 38.
- Do not remove the CF memory card from the camera during formatting. This may damage the card and render it unusable.
- The following actions should be avoided while saving, deleting or copying images to or from a CF memory card. Such actions may damage the recorded data, or may cause the card to malfunction.
  - Inserting/removing the card
  - Turning the power off
  - Removing the battery
  - Pulling out the AC adapter

## Notes: Using CF memory cards—continued

- Do not attempt to touch the terminals or contacts with your hand or a metal object.
- Do not stress or bend the CF memory card.
- Most CF memory cards, being slight and durable, are immune to physical shock. However, certain CF memory cards contain mechanical parts and may be damaged by being dropped or struck by a hard object.
- Avoid subjecting CF memory cards to excessive heat, humidity, magnetic fields or direct sunlight. CF memory cards are not damaged by X-ray equipment used in aircraft security.

## Operating Conditions

### Windows®

Computer	PC/AT compatible
CPU	MMX Pentium or greater
OS	Windows®98/98SE, Windows® Millennium Edition (Me), Windows®2000 or later pre-installed model*1
RAM	32MB or more (64MB or more recommended) *2
Hard Disk Space	15MB for installation and twice the memory size of the CF memory card*2
Video Resolution	640 x 480 pixels or greater with 16-bit RGB or more (800 x 600 pixels or more, full color recommended)
CD-ROM Drive	Required for installation
Interface	USB interface (built-in only)*3

### Macintosh

Computer	iMac, iMac DV, Power Mac G3 (blue and white), Power Macintosh G4 or later, iBook, PowerBook G3 or later*4
CPU	Power PC G3 or greater
OS	Mac OS 8.6*5, 9.0, 9.1
RAM	32MB or more (64MB or more recommended)*2
Hard Disk Space	15MB for installation and twice the memory size of the CF memory card*2
Video Resolution	640 x 480 pixels or greater with 16-bit RGB or more (800 x 600 pixels or more, full color recommended)
CD-ROM Drive	Required for installation
Interface	USB interface (built-in only)*3

\*1 Only for pre-install model.

\*2 Refer to the software instruction manuals for the required memory when used in combination with other software.

\*3 Camera may not function correctly when connected to a USB hub.

\*4 Make sure that your computer is fitted with a USB interface.

\*5 Users of Mac OS 8.6 will need to upgrade to version 1.3.5 of the Apple Computer USB driver.

## Cleaning

### Lens/Viewfinder

Use blower to remove dirt or dust. Wipe carefully with soft cloth to remove fingerprints or other stains. Do not touch with fingers.

### Monitor

Clean with soft, dry cloth.

### Body

Clean with damp cloth; dry immediately.

**Do not use alcohol, thinner, or other volatile cleaners.**

## Storage

If you are not going to use the camera for a long period of time, remove the battery before putting the camera away.

Store with the lens rotated to a position adjacent to the Control panel. Do not store your camera in locations that:

- are poorly ventilated or damp
- are next to equipment that produces strong magnetic fields, such as televisions or radios
- are hotter than 50°C (122°F) or colder than -10°C (14°F)
- have a humidity of over 60%

# Troubleshooting







If the COOLPIX995 is not operating properly, check the following items. If the problem persists, contact the retailer where you bought this camera or an authorized Nikon dealer or service center.

	Problem	Check points	Page
Power	Power does not turn on.	<ul style="list-style-type: none"> <li>Battery level is low.</li> <li>Battery is incorrectly installed.</li> <li>AC adapter is incorrectly connected.</li> </ul>	31 30 154
	Power turns off immediately.	<ul style="list-style-type: none"> <li>Battery level is low.</li> <li>Using camera at low temperatures.</li> </ul>	31
Shooting	Cannot take photo when Shutter release button is fully depressed.	<ul style="list-style-type: none"> <li>Mode dial is not set to  or  .</li> <li>CF memory card is not compatible with the COOLPIX995.</li> <li>Card memory is full (delete images).</li> <li>Self-timer is selected.</li> <li>The Red LED is flashing slowly indicating that the Speedlight is charging (takes a few seconds).</li> </ul>	44 36 163 60 53 69
	Monitor is blank or images on the Monitor are not clear.	<ul style="list-style-type: none"> <li>Bright sunlight or other high-intensity light is falling on the Monitor. Use the Viewfinder or move to a location where there is less light.</li> <li>The Monitor has become dirty and should be cleaned.</li> </ul>	46
			165
	Photos not in focus.	<ul style="list-style-type: none"> <li>The subject is low-contrast or not suitable for autofocus systems. Try <b>Manual focus</b>.</li> </ul>	81 82
	The Speedlight does not fire.	<ul style="list-style-type: none"> <li>The Speedlight is stowed.</li> <li><b>Int Flash Off</b> setting is "On".</li> <li><b>Continuous</b> mode, <b>Best Shot Selector</b> or <b>Lens</b> mode is selected.</li> </ul>	50 133 99, 102, 106
	Image color is unnatural.	<ul style="list-style-type: none"> <li>The photo was taken under conditions in which white balance could not be adjusted. Try <b>Preset White Balance</b>.</li> </ul>	95



	Problem	Check points	Page
Playback	Cannot play back image.	<ul style="list-style-type: none"> <li>Mode dial is not set to  .</li> <li>The CF memory card does not contain picture data.</li> <li>All image data in the memory card are deleted or card has been formatted.</li> </ul>	44 36 74 138 38
	Playback image is not displayed on TV monitor.	<ul style="list-style-type: none"> <li>Camera is not correctly connected to the TV set.</li> <li>The TV is not set to the Video input.</li> <li>The camera is connected to the antenna/aerial input.</li> </ul>	155
	Image is not displayed clearly/image color is not correct.	<ul style="list-style-type: none"> <li>The camera is not correctly connected to the TV/contact is incorrect (connect camera and TV correctly).</li> <li>TV monitor's setting is not correct (refer to TV instruction manual).</li> </ul>	155
Other	Cannot transmit data to computer.	<ul style="list-style-type: none"> <li>The camera is not correctly connected to the computer (refer to Nikon View 4 instruction manual).</li> </ul>	156

# Error Messages

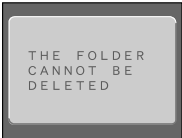

If the following error messages appear on the Monitor or Control panel, please check the possible solutions before ordering repairs or requesting service under Warranty.

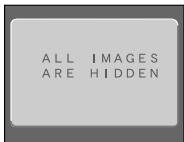
Monitor	Control panel	Problem	Solution	Page
		<ul style="list-style-type: none"> <li>CF memory card is not inserted or is not correctly inserted.</li> </ul>	<ul style="list-style-type: none"> <li>Insert CF memory card correctly.</li> </ul>	36
		<ul style="list-style-type: none"> <li>CF memory card is not formatted for COOLPIX995.</li> </ul>	<ul style="list-style-type: none"> <li>Select <b>Format</b> on the Monitor and format CF memory card.</li> <li>Use a correctly formatted CF memory card.</li> </ul>	38 36
		<ul style="list-style-type: none"> <li>CF memory card does not have sufficient memory/image numbers or folder numbers are over limit.</li> </ul>	<ul style="list-style-type: none"> <li>Delete images and/or reduce number of images (transfer the images you want to save to a computer).</li> <li>Insert a new CF memory card.</li> </ul>	77 138 156  36
		<ul style="list-style-type: none"> <li>An error has occurred when accessing CF memory card.</li> </ul>	<ul style="list-style-type: none"> <li>Check that the card is compatible with the COOLPIX995.</li> <li>CF memory card may be physically damaged. Check that there is no dirt or foreign matter in the connector. Contact authorized Nikon dealer or service center.</li> </ul>	36 163
		<ul style="list-style-type: none"> <li>Folder may contain some hidden or protected image file/file incompatible with COOLPIX995.</li> </ul>	<ul style="list-style-type: none"> <li>Folder may contain photos taken with camera other than COOLPIX995, or image file edited with software.</li> <li>Cancel <b>Protect</b> or <b>Hide Image</b> setting of image file.</li> </ul>	156  142 143

# Error Messages—continued

Monitor	Control panel	Problem	Solution	Page
		<ul style="list-style-type: none"> <li>• Overflow of the image number has occurred.</li> <li>• CF memory card has format incompatible with COOLPIX995.</li> </ul>	<ul style="list-style-type: none"> <li>• File number is over the camera's limit. Replace card with new one, or delete folder or images.</li> <li>• Reformat the card for COOLPIX995.</li> </ul>	60 77 138 38
		<ul style="list-style-type: none"> <li>• Image cannot be displayed because it is set to hidden mode.</li> </ul>	<ul style="list-style-type: none"> <li>• Cancel image's hidden setting with <b>Hide Image</b> menu on Playback menu.</li> </ul>	143
		<ul style="list-style-type: none"> <li>• Image file cannot be displayed.</li> </ul>	<ul style="list-style-type: none"> <li>• Photo has been taken with camera other than COOLPIX 995, 990, 950, 880, 800, 700, 900s and 900, or contains image file edited with software.</li> </ul>	156
	(Err)	<ul style="list-style-type: none"> <li>• An internal memory access error, internal software crash within the camera, or focus or Zoom malfunction.</li> </ul>	<ul style="list-style-type: none"> <li>• Turn the power off and then on again, or reinstall battery. If the error message persists, contact an authorized Nikon dealer or service center.</li> </ul>	30

# Specifications

Type	Digital camera E995	
CCD	1/1.8" high-density CCD, total number of pixels: 3.34 million	
Image size (pixel)	2,048 x 1,536 (FULL)	1,600 x 1,200 (UXGA)
	1,280 x 960 (SXGA)	1,024 x 768 (XGA)
	640 x 480 (VGA)	2,048 x 1,360 (3:2)
Lens	4x Zoom-Nikkor; f=8 - 32mm [35mm (135) format equivalent to 38 - 152mm]/ f/2.6 - 5.1; 10 elements in 8 groups	
Autofocus	Contrast-detect TTL AF; Multi-area AF	
Digital zoom	4.0X	
AF area	5-area multi-AF and Spot AF available	
Focus mode	Continuous autofocus/Single autofocus, Infinity and Macro available, Manual (50 steps) with focus confirmation indication available	
Focus range	30cm (11.8 in.) to infinity (∞); 2cm (0.8 in.) (at middle Zoom position) to infinity (∞) in macro mode, Manual focus	
Viewfinder	Real-image zoom viewfinder with LED indication; diopter adjustment: -2 to +1m <sup>-1</sup>	
Monitor	1.8-in., 110,000-dot, low-temp. polysilicon TFT LCD; brightness adjustment (5 levels), hue adjustment (11 steps); frame coverage: approx. 97%	
Storage	File system: Design rule for Camera File systems, Digital Print-Order Format (DPOF) compliant Compression: JPEG-baseline-compliant; FINE (approx. 1/4), NORMAL (approx. 1/8), BASIC (approx. 1/16), HI (uncompressed: RGB-TIFF)	
Approximate capacity (16 MB)	Compressed: FINE=10, NORMAL=19, BASIC=37 (approx., with 2,048 x 1,536 pixel resolution/16MB memory card)	
Storage media	CompactFlash™ Card (Type I/II)	
Shooting mode	 : Automatic mode  : User setting mode (White Balance, Metering, Best Shot Selector, Saturation Control, Noise Reduction, Image Adjustment and Image Sharpening can be set from the Shooting menu) Custom mode (  ): Three groups of User Settings can be memorized	

Capture modes	Single, Continuous, Multi-shot 16, VGA Sequence, Ultra HS, Movie (40 sec. for QVGA-size frames at 15 fps., QuickTime Movie)
Metering mode	256-segment Matrix, Center-Weighted, Spot, AF Spot
Exposure control	Programmed Auto with Flexible program, Shutter-Priority Auto, Aperture-Priority Auto, Manual, Exposure Compensation (±2 EV in 1/3 EV steps), Auto-Exposure Bracketing
Exposure range	-2.2 to +17.0EV (W) (ISO 100 equivalent)
Shutter	Mechanical and charge-coupled electronic shutter; 1-1/2300 sec. in P mode, 8-1/2000 sec. in S mode, 8-1/2300 sec. in A mode, 8-1/2000 sec., 60 second Bulb in M mode
Aperture	7-blade iris diaphragm; 10 settings in 1/3 EV steps
Sensitivity	ISO 100 equivalent, selectable (Auto, ISO 100, ISO 200, ISO 400, ISO 800 equivalent)
White Balance	Matrix-Auto White Balance, 5-mode Manual, Preset; White Balance Bracketing available
Self-timer	10 sec. or 3 sec. duration
Built-in Speedlight	Guide number: 10/32 (ISO 100, m/ft.) Sync method: automatic sync control Flash mode: 4 modes; Auto Flash, Anytime Flash, Slow Sync, Red-Eye Reduction
Sync terminal	Sync terminal connects to external Nikon Speedlight SB-28/28DX/26/25/24/22/22s through the Multi-Flash Bracket Unit SK-E900 (up to 5 flash units when using AS-10 and SC-18/19)
Auto power-off	Automatically turns off after 30 seconds (or a duration selected from 0.5/1/5/30 min.) after last camera operation
Playback Menu	Full-frame playback, Movie, Quick review, Full-screen review, Thumbnail (4/9 segments), Slide show, Zoom playback (up to 6X); Shooting data display, All shooting data display and histogram indication, Focus confirmation indication
Delete function	Quick delete, delete all frames, delete selected frame(s), delete folder, card format; Disable delete available

# Specifications—continued

Interface	USB, video output (NTSC/PAL selectable)
I/O terminal	DC input, Video output, Digital terminal (USB), Sync terminal
Power requirements	One Li-ion Rechargeable Battery EN-EL1, or one 6V lithium battery (2CR5/DL245) (optional) External power source (8.4V, 1.3A)
Battery life	Approx. 110 min. when using the Monitor and one Li-ion Rechargeable Battery EN-EL1 at normal temperature (20°C/68°F)
Operating environment	Temperature: 0°C to 40°C (32°F to 104°F) Humidity: under 85% (without condensation)
Dimensions (W x H x D)	138 x 82 x 40mm/5.4 x 3.2 x 1.6 in. (Grip: 59mm/2.3 in.)
Weight	Approx. 390g/13.8 oz. (without battery)
Supplied accessories	Li-ion Rechargeable Battery EN-EL1, Battery Charger, USB Cable, Video cable, CompactFlash™ (CF) Memory Card, Strap, Lens cap, Instruction manual, Nikon View 4 CD-ROM (contains Nikon View 4 and bundled software), CD-ROM instruction manual for Nikon View 4, "Open Me First!" Envelope

All specifications apply when a fully charged battery is used at normal temperature (20°C/68°F).

Battery life and performance may vary depending on type, operating environment and date of manufacture.

For reference: Number of exposures per battery

	When monitor ON
Li-ion Rechargeable Battery EN-EL1	Approx. 220 frames or 110 min.

\* With Zoom, 30% flash firing, in FINE mode at 20°C/68°F

\* Battery power can be saved by turning off the Monitor and using the Viewfinder.



\* Specifications and equipment are subject to change without notice or obligation on the part of the manufacturer.

## Auto Power Off

The COOLPIX995 Auto Power Off function automatically switches the camera to energy-saving mode after a certain period of time after the last camera operation.

- With Auto Power Off, Control panel and Monitor displays disappear.
- Those camera settings, that were set before Auto Power Off was activated remain in camera memory.
- Do not store the camera while it is in Auto Power Off mode. If the Shutter release button is pressed in Auto Power Off mode, the mode will be canceled.

## Activating Auto Power Off

	In Shooting  ,  mode		In Playback  mode	
	Control panel/ Monitor	During Video output*1	Control panel/ Monitor	During Video output*1
With EN-EL1, 2CR5/DL245	Automatically turns off after selected time (0.5/1/5/30 min.) when other camera controls are not operated (Shooting menu will disappear after 3 min.)*2	Automatically turns Video output off after selected time (0.5/1/5/30 min.) when other camera controls are not operated (Shooting menu will disappear after 3 min.)	Automatically turns off after selected time (0.5/1/5/30 min.) when other camera controls are not operated (Playback menu will disappear after 3 min.)*2	Automatically turns Video output off after selected time (0.5/1/5/30 min.) when other camera controls are not operated (Playback menu will disappear after 3 min.)
With AC adapter	Automatically turns off after 30 min. when other camera controls are not operated	Continues to output even after 30 min. when other camera controls are not operated (only Monitor display disappears)*3	Automatically turns off after 30 min. when other camera controls are not operated	Continues to output even after 30 min. when other camera controls are not operated (only Monitor display disappears)*3

\*1 About Video output, see p. 155.



\*2 Default setting is 30 seconds.

\*3 Press the MONITOR button to turn on the Monitor.

## Canceling Auto Power Off

Lightly pressing the Shutter release button or MONITOR button will cancel Auto Power Off. Displays on the Control panel and the Monitor will reappear. Camera settings made before the Auto Power Off mode will be reactivated.



	3 : 2 size .....	P. 59, 60
	 Shooting mode .....	P. 44, 45
	 Shooting mode .....	P. 44
	 Playback mode .....	P. 44
<b>A</b>	AF/AE Lock .....	P. 80
	Anytime Flash .....	P. 70
	Aperture-Priority Exposure mode .....	P. 66, 110
	Auto (White Balance) .....	P. 95
	Auto Bracketing .....	P. 115
	Auto Flash mode .....	P. 70
	Autofocus mode .....	P. 61
	Auto-Focus Mode .....	P. 112
	Autofocus Target Area (AF Area mode) .....	P. 62, 111
	Auto Off .....	P. 127, 150
	Auto Power Off .....	P. 127, 150, 175
	AUTO Sensitivity .....	P. 72
	Auto Transfer .....	P. 146
<b>B</b>	BASIC mode .....	P. 58, 60
	Best Shot Selector .....	P. 102
	Black-and-White .....	P. 105
	Brightness .....	P. 125, 150
	Built-in Speedlight .....	P. 20, 50
	Built-in Speedlight Flash Cancel .....	P. 133
<b>C</b>	Center-Weighted metering .....	P. 97
	Cloudy (White Balance) .....	P. 95
	CompactFlash™ memory card .....	P. 36, 38, 163
	Continuous AF .....	P. 62, 112
	Continuous .....	P. 99
	Contrast .....	P. 104
	Controls .....	P. 130
	Controls > Memorize .....	P. 130
<b>D</b>	Date/Time setting .....	p. 34, 129, 151
	DCF (Design rule for Camera File System) .....	P. 158
	Delete .....	P. 138
	Delete (Full-frame playback mode) .....	P. 55, 77
	Delete (Thumbnail Playback mode) .....	P. 78
	Delete all images .....	P. 139
	Delete selected image(s) .....	P. 138
	Digital zoom .....	P. 63, 132
	Disable Delete .....	P. 135
	Display mode .....	P. 125
	Distance Units .....	P. 113
	DPOF (Digital Print Order Format) .....	P. 145
<b>E</b>	Exposure Compensation .....	P. 71, 109
	Exposure Lock .....	P. 109
	Exposure mode .....	P. 64, 110
	Exposure Options .....	P. 109
<b>F</b>	Fine (White Balance) .....	P. 95
	FINE mode .....	P. 58, 60
	Fisheye converter .....	P. 106, 162
	Fixed Aperture .....	P. 132
	Flash mode .....	P. 69, 133
	Flexible Program .....	P. 65
	Fluorescent (White Balance) .....	P. 95
	Focus Confirmation display .....	P. 89, 112
	Focus mode .....	P. 61
	Focus Options .....	P. 111
	Folders setting .....	P. 122, 140
	Folders > Options > New .....	P. 122
	Folders > Options > Rename .....	P. 123
	Folders > Options > Delete .....	P. 124
	Formatting CF memory card .....	38, 129, 151
	Full-frame playback mode .....	P. 54, 74, 88
	FULL mode .....	P. 59, 60
	Full-Screen Review mode .....	P. 51, 87
	FUNC. 1 .....	P. 14, 130
	FUNC. 2 .....	P. 14, 131
<b>G</b>	Green LED .....	P. 16, 20, 48
<b>H</b>	Hide Image .....	P. 143
	HI mode .....	P. 58, 60
	Histogram display .....	P. 89
	Holding the image on the display .....	P. 85
	Hue .....	P. 126, 150
<b>I</b>	Image Adjustment .....	P. 104
	Image file name .....	P. 128, 160
	Image Quality .....	P. 58
	Image Sharpening .....	P. 114
	Image Size .....	P. 59
	Incandescent (White Balance) .....	P. 95
	Infinity mode .....	P. 61
	info.txt .....	P. 134, 160
	Interval setting .....	P. 141

- L** Language.....p. 32, 135, 152  
 Lens converter.....P. 106  
 Long time exposure.....P. 68
- M** Macro Close-up mode.....P. 61  
 Manual Exposure mode.....P. 67, 110  
 Manual Focus.....P. 81  
 Matrix Metering.....P. 97  
 Metering method.....P. 97  
 Multi-shot 16.....P. 99  
 Monitor button.....P. 16, 46  
 Monitor Options.....P. 125, 150  
 MOV.....P. 83, 160  
 Movie.....P. 83, 99
- N** Noise Reduction.....P. 117  
 NORMAL mode.....P. 58, 60  
 NTSC.....P. 135, 151  
 Number of remaining shots.....P. 60
- P** PAL.....P. 135, 151  
 Playback SET-UP.....P. 27, 148  
 Playback menu.....P. 26, 136  
 Playback mode.....P. 44, 54, 74  
 Preset White Balance.....P. 96  
 Print Set (DPOF).....P. 144  
 Programmed Auto Exposure mode.....P. 65, 110  
 Protect.....P. 142
- Q** Quick Delete.....P. 85  
 Quick Review mode.....P. 51, 86  
 QVGA.....P. 83, 99
- R** Red-Eye Reduction.....P. 70  
 Red-Eye Reduction lamp.....P. 14, 70  
 Red LED.....P. 16, 20, 48  
 Reset All.....P. 118  
 Reset Trns/Print.....P. 139
- S** Saturation Control.....P. 105  
 Self-timer.....P. 53, 61  
 Sensitivity.....P. 72  
 Sensitivity setting.....P. 72  
 Seq. Numbers.....P. 128  
 Shooting SET-UP.....P. 24, 120-135  
 Shooting menu.....P. 22, 92  
 Shooting mode.....P. 44  
 Shot confirm lamp.....P. 134  
 Shutter-Priority Exposure mode.....P. 66, 110  
 Shutter Sound.....P. 127, 150  
 Single AF.....P. 62, 112  
 Single shooting.....P. 99  
 Slide show.....P. 140  
 Slow Sync Flash.....P. 70  
 Speedlight (White Balance).....P. 95  
 Spot AF Area.....P. 98  
 Spot metering.....P. 97  
 Swivel Lock.....P. 106  
 SXGA.....P. 59, 60
- T** Telephoto converter.....P. 106, 162  
 Thumbnail mode.....P. 55, 76  
 TIFF.....P. 160
- U** Ultra HS shooting.....P. 99  
 USB.....P. 157  
 User Settings.....P. 108
- V** Variable Power (Speedlight Options).....P. 133  
 VGA Sequence shooting.....P. 99  
 VGA size.....P. 59, 60  
 Video Mode.....P. 135, 151
- W** White Balance.....P. 95  
 White Balance Bracketing.....P. 116  
 Wide-angle converter.....P. 106, 162
- X** XGA size.....P. 59, 60
- Z** Zoom.....P. 47, 54, 132  
 Zooming in.....P. 75  
 Zoom Options > Startup Position.....P. 132

No reproduction in any form of this manual, in whole or in part (except for brief quotation in critical articles or reviews), may be made without written authorisation from NIKON CORPORATION.

***Nikon***



**NIKON CORPORATION**

FUJI BLDG., 2-3, MARUNOUCHI 3-CHOME,  
CHIYODA-KU, TOKYO 100-8331, JAPAN

Printed in Japan 6MEA1301-03